



SPOA82 Capacity 7,000 lbs.

TLO7 Capacity 5,250 lbs. (2,381 kg) For 3-Wheel Vehicles
Capacity 7,000 lbs. (3,175 kg) For 4-Wheel Vehicles

SPO10W Capacity 6,000 lbs.

(Refer to Runway Manufacturer for Runway Capacity)
(500 Series Lifts)

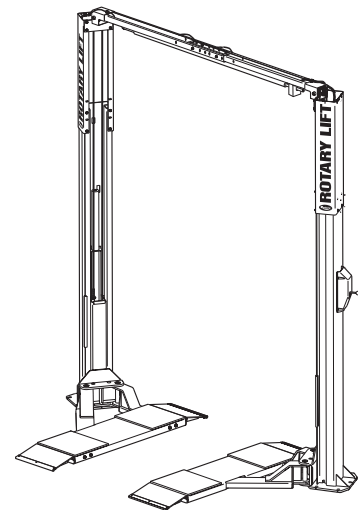
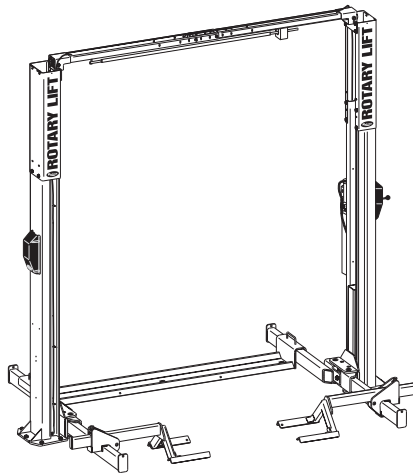
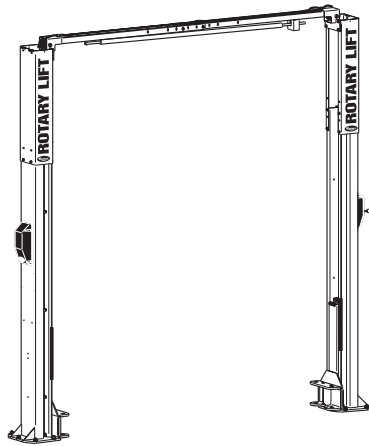

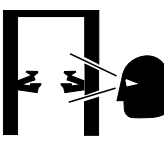
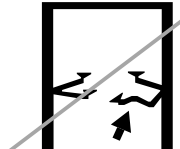
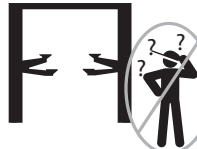



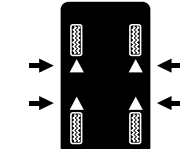

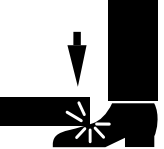

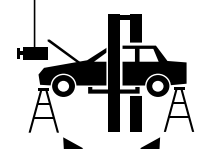

Table of Contents

- Safety Instructions 2
- Owner/Employer Responsibilities 3
- Operating Instructions (SPO10W)..... 4
- Operating Instructions (SPOA82) 6
- Operating Instructions (TLO7) 8
- Maintenance Instructions 10
- Trouble Shooting..... 11
- Lift Lockout/Tagout Procedure 12
- Operating Conditions..... 13
- Approved Accessories..... 13

Installer: Please return this booklet to literature package and give to lift owner/operator.

OPERATION & MAINTENANCE MANUAL

SAFETY INSTRUCTIONS

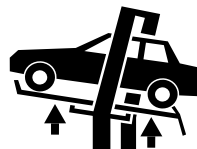
<p>SAFETY INSTRUCTIONS</p>  <p>Proper maintenance and inspection is necessary for safe operation. ©</p>	<p>SAFETY INSTRUCTIONS</p>  <p>Do not operate a damaged lift. ©</p>	<p>CAUTION</p>  <p>Lift to be used by trained operator only. ©</p>
<p>CAUTION</p>  <p>Authorized personnel only in lift area. ©</p>	<p>SAFETY INSTRUCTIONS</p>  <p>Read operating and safety manuals before using lift. ©</p>	
<p>WARNING</p>  <p>Position vehicle with center of gravity midway between adapters. ©</p>	<p>CAUTION</p>  <p>Use vehicle manufacturer's lift points. ©</p>	
<p>WARNING</p>  <p>Do not override self-closing lift controls. ©</p>		
<p>WARNING</p>  <p>Keep feet clear of lift while lowering. ©</p>	<p>WARNING</p>  <p>Remain clear of lift when raising or lowering vehicle. ©</p>	<p>CAUTION</p>  <p>Always use safety stands when removing or installing heavy components. ©</p>
<p>WARNING</p>  <p>Avoid excessive rocking of vehicle while on lift. ©</p>	<p>WARNING</p>  <p>Clear area if vehicle is in danger of falling. ©</p>	<p>CAUTION</p>  <p>Auxiliary adapters may reduce load capacity. ©</p>

- **Daily** inspect your lift. Never operate if it malfunctions or if it has broken or damaged parts. Use **only** qualified lift service personnel and genuine Rotary parts to make repairs.
 - **Thoroughly** train all employees in use and care of lift, using manufacturer's instructions and "Lifting It Right" and "Safety Tips" supplied with the lift.
 - **Never** allow unauthorized or untrained persons to position vehicle or operate lift.
 - **Prohibit unauthorized persons from being in shop area while lift is in use.**
 - **Do Not** permit anyone on lift or inside vehicle when it is either being raised or lowered.
 - **Always** keep area around lift free of tools, debris, grease and oil.
 - **Never** overload lift. Capacity of lift is shown on nameplate affixed to the lift.
 - **Do Not** stand in front of the vehicle while it is being positioned in lift bay. •
 - **Before** driving vehicle into lift bay, BE SURE lift is fully lowered.
 - **Do Not** hit or run over lift arms or adapters. This could damage lift or vehicle. Before driving vehicle into lift bay, position arms and adapters to provide unobstructed entrance onto lift.
 - **Load** vehicle on lift carefully. Position lift adapters to contact at the vehicle manufacturer's recommended lift points. Raise lift until adapters contact vehicle. Check adapters for secure contact with vehicle. Raise lift to desired working height.
- CAUTION** DO NOT go under vehicle if locking latches are not engaged.
- **Do Not** block open or override self-closing lift controls; they are designed to return to the "Off" or Neutral position when released.
 - **Do Not** remove or disable arm restraints.
 - **Remain** clear of lift when raising or lowering vehicle.
 - **Always** use safety stands when removing or installing heavy components.
 - **Avoid** excessive rocking of vehicle while on lift.
 - **Clear** area if vehicle is in danger of falling.
 - **Remove** tool trays, stands, etc. before lowering lift.
 - **Release** locking latches before attempting to lower lift.
 - **Position** lift arms and adapters to provide an unobstructed exit before removing vehicle from lift area.

The Owner/Employer:



- Shall ensure that lift operators are qualified and that they are trained in the safe use and operation of the lift using the manufacturer's operating instructions; ALI/SM01-1, *ALI Lifting it Right* safety manual; ALI/ST-90 *ALI Safety Tips* card; ANSI/ALI ALOIM-2000, *American National Standard for Automotive Lifts-Safety Requirements for Operation, Inspection and Maintenance*; ALI/WL Series, *ALI Uniform Warning Label Decals/Placards*; and in the case of frame engaging lifts, ALI/LP-GUIDE, *Vehicle Lifting Points/Quick Reference Guide for Frame Engaging Lifts*.
- Shall establish procedures to periodically inspect the lift in accordance with the lift manufacturer's instructions or ANSI/ALI ALOIM-2000, *American National Standard for Automotive Lifts-Safety Requirements for Operation, Inspection and Maintenance*; and The Employer Shall ensure that lift inspectors are qualified and that they are adequately trained in the inspection of the lift.
- Shall establish procedures to periodically maintain the lift in accordance with the lift manufacturer's instructions or ANSI/ALI ALOIM-2000, *American National Standard for Automotive Lifts-Safety Requirements for Operation, Inspection and Maintenance*; and The Employer Shall ensure that lift maintenance personnel are qualified and that they are adequately trained in the maintenance of the lift.
- Shall maintain the periodic inspection and maintenance records recommended by the manufacturer or ANSI/ALI ALOIM-2000, *American National Standard for Automotive Lifts-Safety Requirements for Operation, Inspection and Maintenance*.
- Shall display the lift manufacturer's operating instructions; ALI/SM 93-1, *ALI Lifting it Right* safety manual; ALI/ST-90 *ALI Safety Tips* card; ANSI/ALI ALOIM-2000, *American National Standard for Automotive Lifts-Safety Requirements for Operation, Inspection and Maintenance*; and in the case of frame engaging lifts, ALI/LP-GUIDE, *Vehicle Lifting Points/Quick Reference Guide for Frame Engaging Lifts*; in a conspicuous location in the lift area convenient to the operator.
- Shall provide necessary lockout/tagout means for energy sources per ANSI Z244.1-1982 (R1993), *Safety Requirements for the Lockout/Tagout of Energy Sources*, before beginning any lift repairs.
- Shall not modify the lift in any manner without the prior written consent of the manufacturer.

SPO10W OPERATING INSTRUCTIONS

⚠️ WARNING

To avoid personal injury and/or property damage, permit only trained personnel to operate lift. After reviewing these instructions, get familiar with lift controls by running the lift through a few cycles before loading vehicle on lift.

📌 IMPORTANT

Always lift the vehicle using all four adapters. **NEVER** raise just one end, one corner, or one side of vehicle.



DO NOT go under vehicle if locking latches are not engaged.



Before attempting to lift pickup trucks or other truck frame vehicles, be sure that:

- Vehicle frame is strong enough to support its weight and has not been weakened by modification or corrosion.
- Vehicle individual axle weight does not exceed one-half lift capacity.
- Adapters are in secure contact with frame at vehicle manufacturer's recommended lift points.
- Vehicle is stable on lift and neither front nor "tail" heavy.
- The overhead switch bar will contact the highest point on the vehicle.
- Rotate front and rear adapter to oppose each other when using the high step adapter and/or any auxiliary height extending adapter.

Observe and heed SAFETY, CAUTION and WARNING labels on the lift.

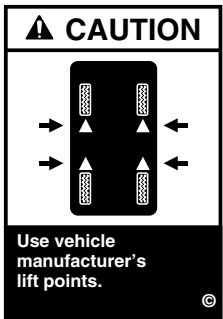

- Lift must be fully lowered and service bay clear of all personnel before the vehicle is brought on lift. Swing arms out to full drive-thru position.
- Spot vehicle over lift with left front wheel in proper spotting position, Fig. 1.
- Loading:** Swing arms under vehicle and position adapters at vehicle manufacturer's recommended lift points, Fig. 2. Use intermediate, high step, or optional adapters for under body clearance when required.



Note: Allow 2 seconds between motor starts. Failure to comply may cause motor burnout.

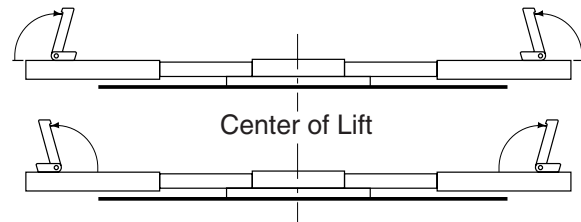

4. To Raise Lift:

- For all lifts. Push RAISE switch on power unit, Fig. 3.
- Stop before making contact with vehicle. Check arm restraint pins for engagement. If required, slightly move arm to allow restraint gear and pawl to mesh. DO NOT hammer pin down as this will damage the restraint gear teeth.
- Raise vehicle until tires clear the floor.
- Stop and check adapters for secure contact at vehicle manufacturer's recommended lift points.
- Continue to raise to desired height **only** if vehicle is secure on lift.
- DO NOT** go under vehicle if all four adapters are not in secure contact at vehicle manufacturer's recommended lift points.
- Repeat complete spotting, loading and raising procedures if required.
- Lower lift onto locking latches.

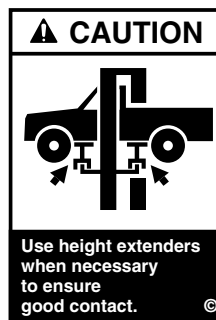

5. While Using Lift:

- Avoid excessive rocking of vehicle while on lift.
- Always use safety stands as needed or when removing or installing heavy components.

6. To Lower Lift:

- Remove all tools or other objects from lift area.
- Raise lift off locking latches.
- Pull LATCH release handle fully and hold.
- Push LOWERING valve handle to lower, Fig. 3.

Note: Both LATCH release and LOWERING valve handles are deadman-type design. Each must be held down to lower lift. Do not override self-closing lift controls.

SAFETY INSTRUCTIONS

Proper maintenance and inspection is necessary for safe operation. ©

7. Remain clear of lift when lowering vehicle. Observe pinch point warning decals.
8. Remove adapters from under vehicle and swing arms to full drive-thru position before moving vehicle.
9. If lift is not operating properly, **Do Not** use until adjustment or repairs are made by qualified lift service personnel.

CAUTION

Always use safety stands when removing or installing heavy components. ©

WARNING

Do not override self-closing lift controls. ©

WARNING

Remain clear of lift when raising or lowering vehicle. ©

SAFETY INSTRUCTIONS

Do not operate a damaged lift. ©

SAFETY INSTRUCTIONS

Proper maintenance and inspection is necessary for safe operation. ©

WARNING

Keep feet clear of lift while lowering. ©

Typical Wheel Spotting Positions

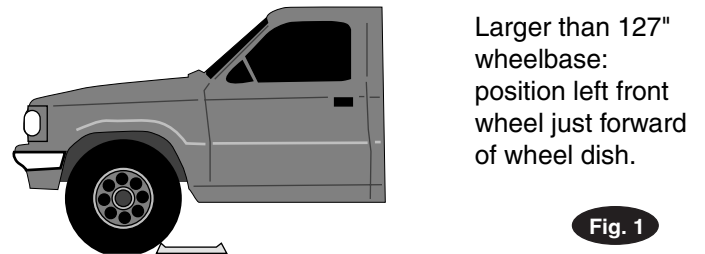
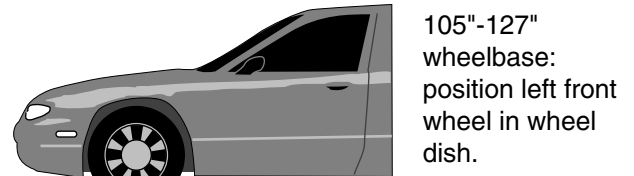
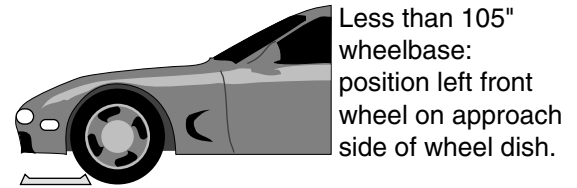
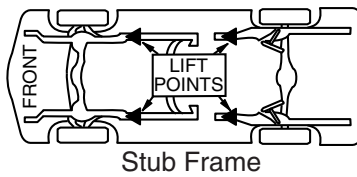
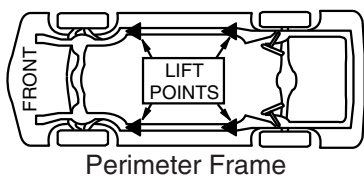
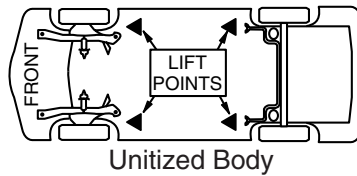
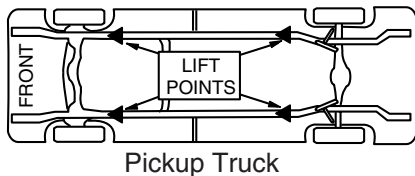

Fig. 1

WARNING Most specialty or modified vehicles cannot be raised on a frame engaging lift. Contact vehicle manufacturer for raising or jacking details.

Typical Lifting Points



NOTE: Some vehicles may have the manufacturer's Service Garage Lift Point locations identified by triangle shape marks on its undercarriage (reference ANSI/SAE J2184-1992). Also, there may be a label located on the right front door lock face showing specific vehicle lift points. If the specific vehicle lift points are not identified, refer to the "Typical Lift Points" illustrated herein. **ALWAYS** follow the operating instructions supplied with the lift.

Fig. 2

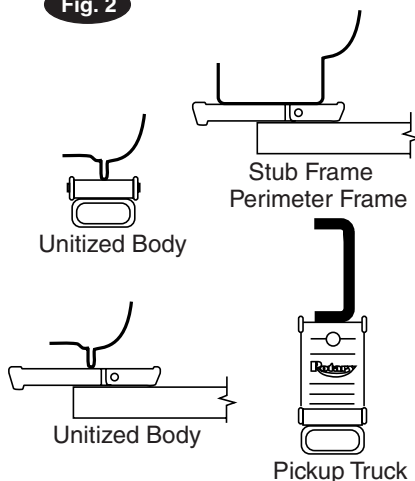

THREE PHASE

SINGLE PHASE

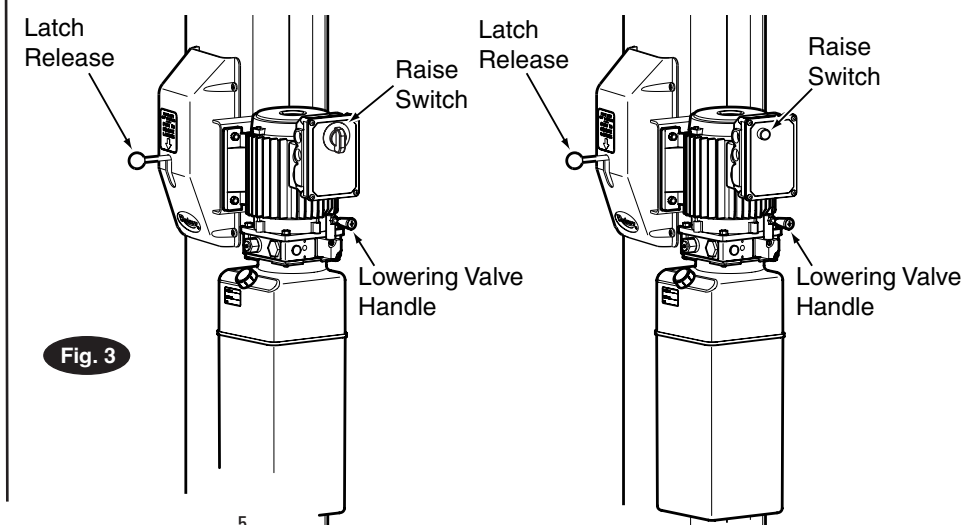

Fig. 3

SPOA82 OPERATING INSTRUCTIONS

⚠ WARNING To avoid personal injury and/or property damage, permit only trained personnel to operate lift. After reviewing these instructions, get familiar with lift controls by running the lift through a few cycles before loading vehicle on lift.

IMPORTANT Always lift the vehicle using all four adapters. **NEVER** raise just one end, one corner, or one side of vehicle.



Observe and heed **SAFETY, CAUTION and WARNING** labels on the lift.

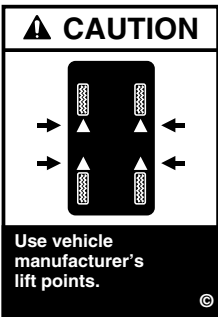

1. Lift must be fully lowered and service bay clear of all personnel before the vehicle is brought on lift. Swing arms out to full drive-thru position.
2. Spot vehicle over lift with left front wheel in proper spotting dish position, Fig. 5. Be sure vehicle wheels and/or mud flaps clear pad end ramps.
3. **Loading:** DO NOT raise limousines or pickup trucks. DO NOT raise SUV's, vans, or other specialty vehicles not of a unibody construction.

Before lifting vehicle be sure that:

- A. Pads are in secure contact with frame or support structure at outer body.
- B. Certain vehicles such as Camaro, Firebird, Escort, or Chrysler "K" Cars or others may require additional clearance under carriage or exhaust

system from contacting pad support. Use 3" high auxiliary rubber pads. Locate under frame or support structure at outer body using vehicle manufacturer's recommended pick up points.

Note: Allow 2 seconds between motor starts. Failure to comply may cause motor burnout.

4. To Raise Lift:

- A. Push RAISE switch on power unit, Fig. 4.
- B. Stop before making contact with vehicle. Be sure wheels and/or mud flaps clear pad end ramps.
- C. Raise vehicle until tires clear the floor.
- D. Stop and check pads for secure contact at vehicle manufacturer's recommended lift points.
- E. Continue to raise to desired height **only** if vehicle is secure on lift.
- F. Repeat complete spotting, loading and raising procedures if required.
- H. Lower lift onto locking latches.

⚠ CAUTION DO NOT go under vehicle if locking latches are not engaged.

5. While Using Lift:

- A. Avoid excessive rocking of vehicle while on lift.
- B. Always use safety stands as needed or when removing or installing heavy components.

6. To Lower Lift:

- A. Remove all tools or other objects from lift area.
- B. Raise lift off locking latches.
- C. Pull LATCH release handle fully and hold.
- D. Push LOWERING valve handle to lower, Fig. 4.

Note: Both LATCH release and LOWERING valve handles are deadman-type design. Each must be held down to lower lift. Do not override self-closing lift controls.

7. Remain clear of lift when lowering vehicle. Observe pinch point warning decals.
8. Remove adapters from under vehicle. Be sure lift is fully lowered before removing vehicle.
9. If lift is not operating properly, **Do Not** use until adjustment or repairs are made by qualified lift service personnel.

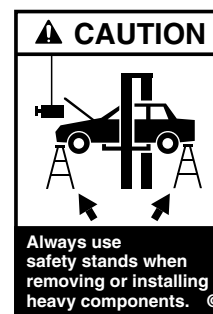
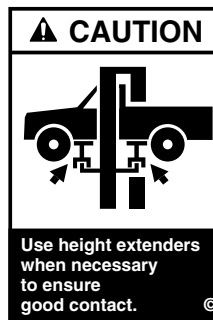

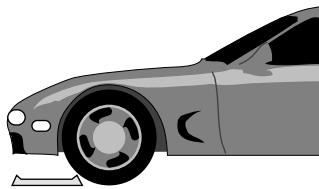
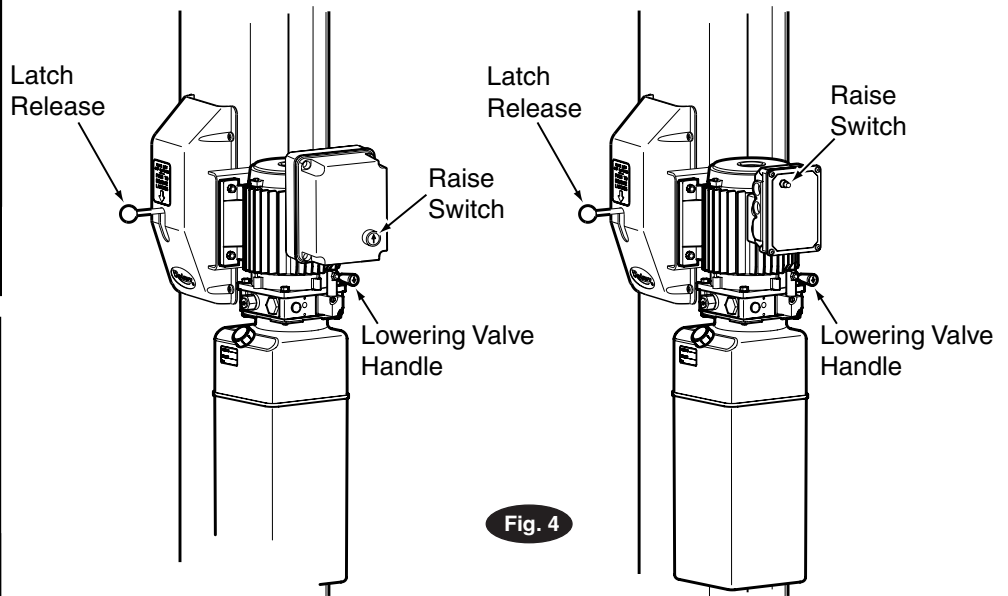

Less than 105" wheelbase:
position left front wheel on approach side of wheel dish.

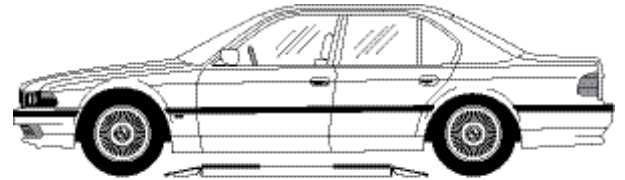

Vehicle Spotting Position

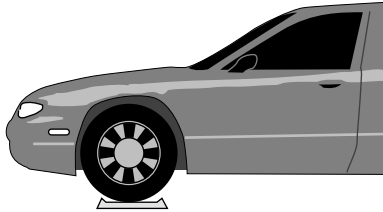

105"-127" wheelbase:
position left front wheel in wheel dish.

Fig. 5

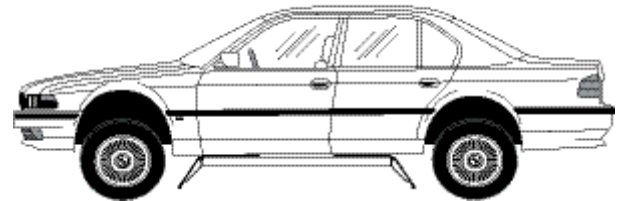

Vehicle Loading Position

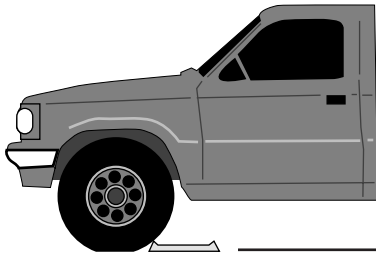

Larger than 127" wheelbase:
position left front wheel just forward of wheel dish.

Typical Lifting Points

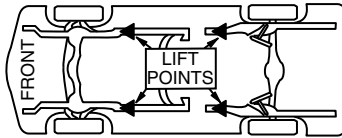
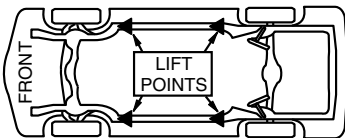
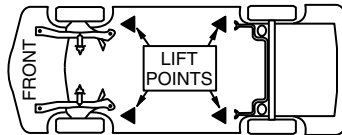
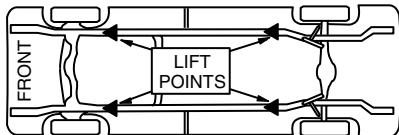

Fig. 6

NOTE: Some vehicles may have the manufacturer's Service Garage Lift Point locations identified by triangle shape marks on it's undercarriage. Also, there may be a label located on the right front door lock face showing specific vehicle lift points. If the specific vehicle lift points are not identified, refer to the "Typical Lift Points" illustrated herein. ALWAYS follow the operating instructions supplied with the lift.



NOTE: This style lift is not recommended for pickup trucks or vehicles with truck frames.

TLO7 OPERATING INSTRUCTIONS

⚠️ WARNING

To avoid personal injury and/or property damage, permit only trained personnel to operate lift. After reviewing these instructions, get familiar with lift controls by running the lift through a few cycles before loading vehicle on lift.

IMPORTANT

NEVER raise just one end, one corner, or one side of vehicle.

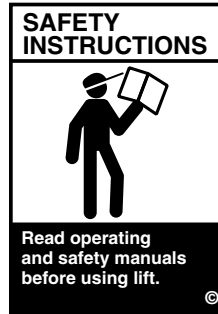

Observe and heed SAFETY, CAUTION and WARNING labels on the lift.

1. Before Loading:

- Lift must be fully lowered and service bay clear of all personnel before the vehicle is brought on lift.
- Position rear pan weldment and front forks so that they match vehicle wheel base and are centered on columns.
- Assure Forks and pan weldment are free from grease and oil.
- Retract forks to give widest drive through.

2. Loading:

- Position vehicle with the rear wheels centered on the rear pan weldment. (Driving over forks is permitted with wide vehicles).
- Move forks so the front wheels are fully cradled.
- Use small wheel adapter on forks when necessary, see Fig.7.
- For 3-wheel vehicles, center single wheel on rear ramp.

⚠️ CAUTION

Use small wheel adapter kit when raising vehicles with less than 13" wheels. Be sure to engage dowel screw.

3. To Raise Lift:

- Push RAISE switch on power unit, Fig. 8.
- Raise vehicle until tires clear the floor.
- Stop and check for stable contact with vehicle.
- Continue to raise to desired height **only** if vehicle is secure on lift.
- Lower lift onto locking latches.
- See typical loading, Fig. 9.

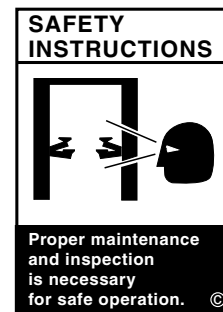

⚠️ CAUTION

DO NOT go under vehicle if locking latches are not engaged.

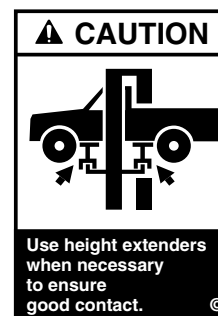
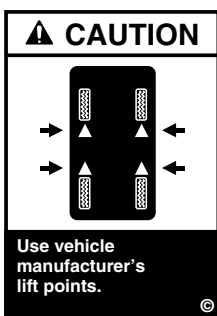



4. While Using Lift:

- Avoid excessive rocking of vehicle while on lift.
- Always use safety stands as needed or when removing or installing heavy components.

5. To Lower Lift:

- Remove all tools or other objects from lift area.
- Remain clear of lift when lowering vehicle. Observe pinch point warning decals.
- Raise lift off locking latches.
- Push LATCH release handle fully and hold.
- Pull LOWERING valve handle to lower, Fig. 8.

Note: Both LATCH release and LOWERING valve handles are deadman-type design. Each must be held down to lower lift. Do not override self-closing lift controls.

WARNING If lift is not operating properly, **Do Not** use until adjustment or repairs are made by qualified lift service personnel.

CAUTION Use small wheel adapter kit when raising vehicles with less than 13" wheels. Be sure to engage dowel screw.

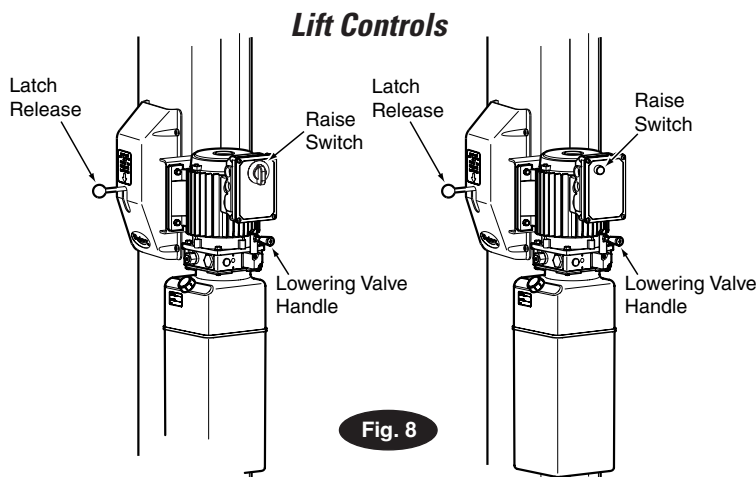
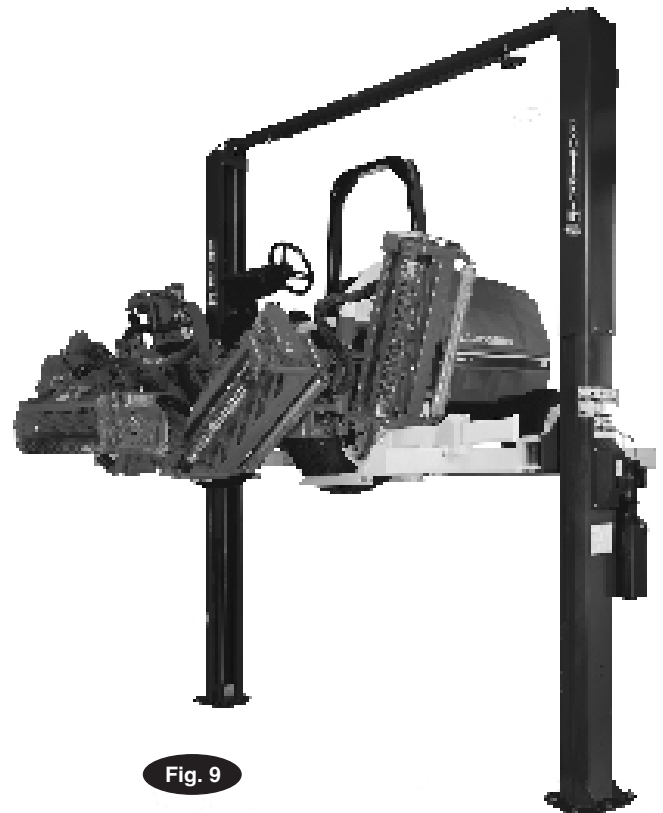
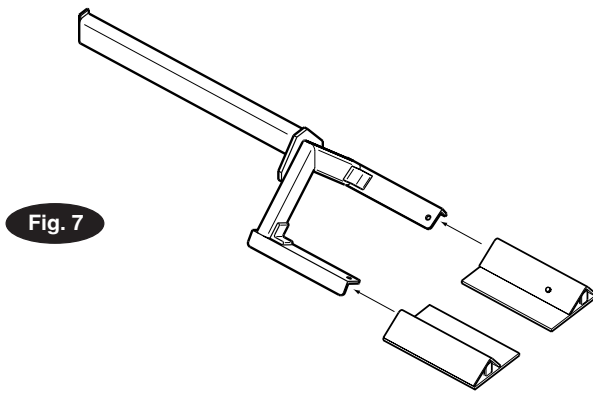

MAINTENANCE INSTRUCTIONS

If you are not completely familiar with automotive lift maintenance procedures; STOP: Contact factory for instructions. To avoid personal injury, permit only qualified personnel to perform maintenance on this equipment.

- Always keep bolts tight. Check periodically.
- Always keep lift components clean.
- Always if oil leakage is observed, call local service representative.
- Always if electrical problems develop, call local service representative.
- Daily: Check cables and sheaves for wear. Observe for frayed cable strands. Wipe cables with a rag to detect hard to see small broken cable strands. Replace cables showing any broken strands. Replace worn parts as required with genuine Rotary parts.
- Daily: (SPOA82/TLO7 only) Inspect rubber pads for damage or excessive wear. Replace as required with genuine Rotary parts.
- Daily: Inspect adapters for damage or excessive wear. Replace as required with genuine Rotary parts.
- Monthly: Check equalizer cable tension. Adjust per lift installation instructions. If there are no more threads available for adjustment, replace the cable. Do not use washers to stand off the nut to use previously used threads.
- Monthly: Lubricate locking latch shafts. Push latch handle several times for oil to penetrate pivot points.
- Monthly: (TLO7 only) Coat the latch cable guide contact surface with a light grease such as "TUFOIL".
- Every 3 Months: Check anchor bolts for tightness. Anchors should be torqued to 65 ft/lbs.
- Semi-Annually: Check fluid level of lift power unit and refill if required per lift installation instructions.
- If Lift stops short of full rise or chatters, check fluid level and bleed both cylinders per lift installation instructions.

- Replace all caution, warning or safety related decals on the lift if unable to read or missing. Reorder labels from Rotary Lift.

INSPECTION and MAINTENANCE

See ANSI/ALI ALOIM booklet for periodic inspection checklist and maintenance log sheet.





 WARNING Clear area if vehicle is in danger of falling.	 WARNING Position vehicle with center of gravity midway between adapters.
 WARNING Remain clear of lift when raising or lowering vehicle.	 WARNING Avoid excessive rocking of vehicle while on lift.
 WARNING Do not override self-closing lift controls.	 WARNING Keep feet clear of lift while lowering.

The messages and pictographs shown are generic in nature and are meant to generally represent hazards common to all automotive lifts regardless of specific style.

Funding for the development and validation of these labels was provided by the Automotive Lift Institute, PO Box 33116 Indialantic, FL. 32903-3116.

They are protected by copyright. Set of labels may be obtained from ALI or its member companies.

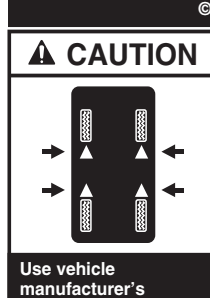
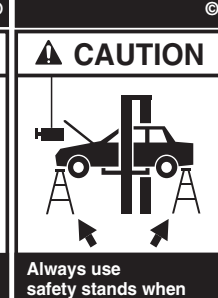
© 1992 by ALI, Inc. ALIWL101w

 CAUTION Lift to be used by trained operator only.	 CAUTION Authorized personnel only in lift area.
 CAUTION Use vehicle manufacturer's lift points.	 CAUTION Always use safety stands when removing or installing heavy components.
 CAUTION Use height extenders when necessary to ensure good contact.	 CAUTION Auxiliary adapters may reduce load capacity.

The messages and pictographs shown are generic in nature and are meant to generally represent hazards common to all automotive lifts regardless of specific style.

Funding for the development and validation of these labels was provided by the Automotive Lift Institute, PO Box 33116 Indialantic, FL. 32903-3116.

They are protected by copyright. Set of labels may be obtained from ALI or its member companies.

© 1992 by ALI, Inc. ALIWL101c

 SAFETY INSTRUCTIONS Read operating and safety manuals before using lift.	 SAFETY INSTRUCTIONS Proper maintenance and inspection is necessary for safe operation.
 SAFETY INSTRUCTIONS Do not operate a damaged lift.	<p>The messages and pictographs shown are generic in nature and are meant to generally represent hazards common to all automotive lifts regardless of specific style.</p> <p>Funding for the development and validation of these labels was provided by the Automotive Lift Institute, PO Box 33116 Indialantic, FL. 32903-3116.</p> <p>They are protected by copyright. Set of labels may be obtained from ALI or its member companies.</p> <p>© 1992 by ALI, Inc. ALIWL101s</p>

TROUBLE SHOOTING

Trouble	Cause	Remedy
Motor does not run.	<ol style="list-style-type: none"> 1. Blown fuse or circuit breaker. 2. Incorrect voltage to motor. 3. Bad wiring connections. 4. Motor up switch burned out. 5. Overhead limit switch burned out. 6. Motor windings burned out. 	<ol style="list-style-type: none"> 1. Replace blown fuse or reset circuit breaker. 2. Supply correct voltage to motor. 3. Repair and insulate all connections. 4. Replace switch. 5. Replace switch. 6. Replace motor.
Motor runs but will not raise lift.	<ol style="list-style-type: none"> 1. Open lowering valve. 2. Pump sucking air. 3. Suction stub off pump. 4. Low oil level. 	<ol style="list-style-type: none"> 1. Repair or replace lowering valve. 2. Tighten all suction line fittings. 3. Replace suction stub. 4. Fill tank to proper level with ISOVG32 Hydraulic Oil or Dexron III ATF.
Motor runs—raises unloaded lift but will not raise vehicle.	<ol style="list-style-type: none"> 1. Motor running on low voltage. 2. Debris in lowering valve. 3. Improper relief valve adjustment. 4. Overloading lift. 	<ol style="list-style-type: none"> 1. Supply correct voltage to motor. 2. Clean lowering valve. 3. Replace relief valve cartridge. 4. Check vehicle weight and/or balance vehicle weight on lift.
Lift slowly settles down.	<ol style="list-style-type: none"> 1. Debris in check valve seat. 2. Debris in lowering valve seat. 3. External oil leaks. 	<ol style="list-style-type: none"> 1. Clean check valve. 2. Clean lowering valve. 3. Repair external leaks.
Slow lifting speed or oil blowing out filler breather cap.	<ol style="list-style-type: none"> 1. Air mixed with oil. 2. Air mixed with oil suction. 3. Oil return tube loose. 	<ol style="list-style-type: none"> 1. Change oil using ISOVG32 Hydraulic Oil or Dexron III ATF. 2. Tighten all suction line fittings. 3. Reinstall oil return tube.
Lift going up unlevel.	<ol style="list-style-type: none"> 1. Equalizer cables out of adjustment. 2. Lift installed on unlevel floor. 	<ol style="list-style-type: none"> 1. Adjust equalizer cables to correct tension. 2. Shim lift to level columns (Not to exceed 1/2"). If over 1/2" break out floor and repour per lift installation instructions.
Anchors will not stay tight.	<ol style="list-style-type: none"> 1. Holes drilled oversize. 2. Concrete floor thickness or holding strength not sufficient. 	<ol style="list-style-type: none"> 1. Relocate lift using a new bit to drill holes. Reference installation instructions for minimum spacing requirements. 2. Break out old concrete and repour new pads for lift per lift installation instructions.
Locking latches do not engage.	<ol style="list-style-type: none"> 1. Latch shafts rusted. (Usually occurs on outside installations or in high humidity areas such as vehicle wash bays.) 2. Latch spring broken. 3. Latch cable needs adjustment. 	<ol style="list-style-type: none"> 1. Remove covers, oil latch mechanism. Actuate latch release handle several times to allow oil to coat shaft. 2. Replace broken spring. 3. Adjust clamp at cable end per lift installation instructions.
Locking latches do not disengage.	<ol style="list-style-type: none"> 1. Latch cable is broken. 2. Cable is off sheaves/upper guides. 3. Latch cable is loose. 	<ol style="list-style-type: none"> 1. Replace cable. 2. Check position of cable on sheaves/upper guides; adjust cable tension. 3. Adjust cable tension.
Lift stops short of full rise or chatters.	<ol style="list-style-type: none"> 1. Low oil level. 2. Air in hydraulic lines/cylinder. 	<ol style="list-style-type: none"> 1. Fill tank to proper level with ISOVG32 Hydraulic Oil or Dexron III ATF. 2. Bleed lift per installation instructions.

LIFT LOCKOUT/TAGOUT PROCEDURE

Purpose

This procedure establishes the minimum requirements for the lockout of energy that could cause injury to personnel by the operation of lifts in need of repair or being serviced. All employees shall comply with this procedure.

Responsibility

The responsibility for assuring that this procedure is followed is binding upon all employees and service personnel from outside service companies (i.e., Authorized Rotary Installers, contactors, etc.). All employees shall be instructed in the safety significance of the lockout procedure by the facility owner/manager. Each new or transferred employee along with visiting outside service personnel shall be instructed by the owner/manager (or assigned designee) in the purpose and use of the lockout procedure.

Preparation

Employees authorized to perform lockout shall ensure that the appropriate energy isolating device (i.e., circuit breaker, fuse, disconnect, etc.) is identified for the lift being locked out. Other such devices for other equipment may be located in close proximity of the appropriate energy isolating device. If the identity of the device is in question, see the shop supervisor for resolution. Assure that proper authorization is received prior to performing the lockout procedure.

Sequence of Lockout Procedure

- 1) Notify all affected employees that a lockout is being performed and the reason for it.
- 2) Unload the subject lift. Shut it down and assure the disconnect switch is "OFF" if one is provided on the lift.
- 3) The authorized lockout person operates the main energy isolation device removing power to the subject lift.
 - If this is a lockable device, the authorized lockout person places the assigned padlock on the device to prevent its unintentional reactivation. An appropriate tag is applied stating the person's name, at least 3" x 6" in size, an easily noticeably color, and states not to operate device or remove tag.
 - If this device is a non-lockable circuit breaker or fuse, replace with a "dummy" device and tag it appropriately as mentioned above.
- 4) Attempt to operate lift to assure the lockout is working. Be sure to return any switches to the "OFF" position.
- 5) The equipment is now locked out and ready for the required maintenance or service.

Restoring Equipment to Service

- 1) Assure the work on the lift is complete and the area is clear of tools, vehicles, and personnel.
- 2) At this point, the authorized person can remove the lock (or dummy circuit breaker or fuse) & tag and activate the energy isolating device so that the lift may again be placed into operation.

Rules for Using Lockout Procedure

Use the Lockout Procedure whenever the lift is being repaired or serviced, waiting for repair when current operation could cause possible injury to personnel, or for any other situation when unintentional operation could injure personnel. No attempt shall be made to operate the lift when the energy isolating device is locked out.

OPERATING CONDITIONS

Lift is not intended for outdoor use and has an operating ambient temperature range of 41°-104°F (5°-40°C).

APPROVED ACCESSORIES		
Item	Capacity	Part Number
Air/Electric Utility Box		FA5911
Air/Electric Utility Box Without FRL		FA5910
Filter/Regulator/Lubricator (FRL)		FA5166

Certificate of Compliance

Rotary Lift is authorized to apply ETL & cETL Listing Marks/Labels to this AC Motor. Authorization: ETL Report No. J98007541-003, FAM -UL73. This ETL test certifies that this AC Motor complies with Underwriters Laboratories, Inc. standard ANSI/UL 73, 8th Edition & CSA standard C22.2 No. 68-92.



SV0021 A Rev. 6/9/99

Trained Operators and Regular Maintenance Ensures Satisfactory Performance of Your Rotary Lift.

Replacement Parts: See installers package for parts breakdown sheet. Order Genuine Rotary replacement parts from your nearest Authorized Parts Distributor.

Maintenance Assistance: Contact your local Rotary distributor.

Should further assistance be required, contact Rotary Lift, at one of the phone numbers listed below.

Rotary World Headquarters

2700 Lanier Drive
Madison, IN 47250, USA
www.rotarylif.com

North America Contact Information

Tech. Support: p 800.445.5438
f 800.578.5438
e userlink@rotarylif.com
Sales: p 800.640.5438
f 800.578.5438
e userlink@rotarylif.com

World Wide Contact Information

World Headquarters/USA: 1.812.273.1622
Canada: 1.905.812.9920
European Headquarters/Germany: +49.771.9233.0
United Kingdom: +44.178.747.7711
Australasia: +60.3.7660.0285
Latin America / Caribbean: +54.3488.431.608
Middle East / Northern Africa: +49.771.9233.0



A DOVER COMPANY

