

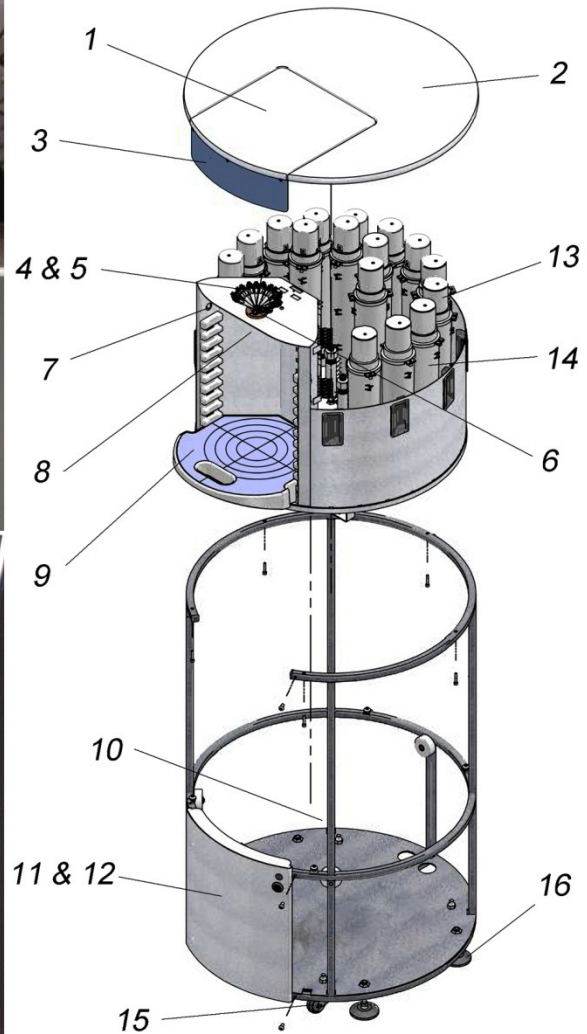

PARTS BREAKDOWN





HERO ARCHIMEDE A200 AUTOMATIC COLORANT DISPENSER

Please use reference numbers to find part numbers and descriptions on the following page. Note, not all parts are shown in below photos.



* Indicates item is not pictured on Parts Breakdown page.

REF#	PART#	IMAGE	DESCRIPTION
1	A20190	NA	OVER-TURNABLE DOOR ASSYMBLY WITH ALL HARDWARE
2	A20185	NA	TOP COVER ASSYMBLY WITH ALL HARDWARE
3	A20160		NOZZLE SHIELD
4	A10262		NOZZLE - SHORT TIP 2.5MM
5	A10352		NOZZLE - LONG TIP 2.5MM
6	A10775		LASER AIMING LIGHT
7	A20750		CAN SENSOR ASSEMBLY
8a	A10305		AUTO CAPPER ASSEMBLY - SHORT ARM
8b	A10341		HUMIDIFIER PAD HOLDER WITHOUT CAP RING

8c	A10342		CAP RING FOR HUMIDIFIER PAD HOLDER
8d	A10347		MOISTURE SEAL FOR AUTO CAPPER / NOZZLE CLUSTER
8e	A10341		HUMIDIFIER PAD HOLDER ASSEMBLY - INCLUDES A10341 & A10342
8f *	A10320		HUMIDIFIER PAD (6 PACK)
8g *	A10323		HUMIDIFIER PAD (12 PACK)
9	A20143		CAN SHELF - BLACK WITH ALUMINUM TOP



10	A20710		MAIN CIRCUIT BOARD - SEQUENTIAL
11 *	A10773		POWER SUPPLY - 67V
12 *	A20772		POWER SUPPLY - 24V
13	A10595		CANISTER COVER ASSY W/ AGITATION MOTOR 2.0L
14	A10580		CANISTER ASSEMBLY - NO COVER OR FITTINGS - 2.0L

See Chart Below.		<p align="center">COMPLETE CANISTER & NOZZLE ASSEMBLY - INCLUDES TUBING / FITTINGS / SPRINGS</p>
------------------	---	---

A20651	CANISTER & NOZZLE ASSEMBLY - INCLUDES TUBING / FITTINGS / SPRINGS - POSITION #1
A20652	CANISTER & NOZZLE ASSEMBLY - INCLUDES TUBING / FITTINGS / SPRINGS - POSITION #2
A20653	CANISTER & NOZZLE ASSEMBLY - INCLUDES TUBING / FITTINGS / SPRINGS - POSITION #3
A20654	CANISTER & NOZZLE ASSEMBLY - INCLUDES TUBING / FITTINGS / SPRINGS - POSITION #4
A20655	CANISTER & NOZZLE ASSEMBLY - INCLUDES TUBING / FITTINGS / SPRINGS - POSITION #5
A20656	CANISTER & NOZZLE ASSEMBLY - INCLUDES TUBING / FITTINGS / SPRINGS - POSITION #6
A20657	CANISTER & NOZZLE ASSEMBLY - INCLUDES TUBING / FITTINGS / SPRINGS - POSITION #7
A20658	CANISTER & NOZZLE ASSEMBLY - INCLUDES TUBING / FITTINGS / SPRINGS - POSITION #8
A20659	CANISTER & NOZZLE ASSEMBLY - INCLUDES TUBING / FITTINGS / SPRINGS - POSITION #9
A20660	CANISTER & NOZZLE ASSEMBLY - INCLUDES TUBING / FITTINGS / SPRINGS - POSITION #10
A20661	CANISTER & NOZZLE ASSEMBLY - INCLUDES TUBING / FITTINGS / SPRINGS - POSITION #11
A20662	CANISTER & NOZZLE ASSEMBLY - INCLUDES TUBING / FITTINGS / SPRINGS - POSITION #12
A20663	CANISTER & NOZZLE ASSEMBLY - INCLUDES TUBING / FITTINGS / SPRINGS - POSITION #13
A20664	CANISTER & NOZZLE ASSEMBLY - INCLUDES TUBING / FITTINGS / SPRINGS - POSITION #14
A20665	CANISTER & NOZZLE ASSEMBLY - INCLUDES TUBING / FITTINGS / SPRINGS - POSITION #15
A20666	CANISTER & NOZZLE ASSEMBLY - INCLUDES TUBING / FITTINGS / SPRINGS - POSITION #16

NA *	A10583		<p align="center">FITTING (BAYONET STYLE) PUMP TO HOSE</p>
---------	--------	---	---

NA *	A10604		<p align="center">SPRING - BEND RESTRICTOR FOR DISPENSE TUBE</p>
---------	--------	---	---

<p>NA *</p>	<p>A10602</p>		<p>THREADED CAP FOR DISPENSE TUBE</p>
<p>15</p>	<p>A10172</p>		<p>CASTER WHEEL WITH THREADED MOUNTING ROD</p>
<p>16</p>	<p>A20171</p>		<p>ADJUSTABLE FOOT WITH THREADED ROD LESS HARDWARE</p>
<p>17 *</p>	<p>A25740</p>		<p>WIRING HARNESS - MAIN CIRCUIT BOARD TO STEPPER MOTOR & AGITATION MOTOR</p>
<p>18 *</p>	<p>A20735</p>		<p>MAIN WIRING HARNESS TO POWER SUPPLY / AUTO CAPPER / AIMING LIGHT / CAN SENSOR</p>
<p>19 *</p>	<p>A20740</p>		<p>AC POWER AND SWITCH WIRING HARNESS ASSEMBLY</p>

ARCHIMEDE COMMON PARTS LIST

Part Number	Description
A10262	NOZZLE - SHORT TIP 2.5MM A200/A250
A10264	NOZZLE * SHORT TIP 4MM A200/A250/A450
A10352	NOZZLE - LONG TIP 2.5MM A200/A250
A10583	FITTING (BAYONET STYLE) PUMP TO HOSE - ALL NEW ARCHIMEDE
A10590	CANISTER COVER ASSY W/ AGITATION MOTOR 2.6L - A160/A210/260
A10595	CANISTER COVER ASSY W/ AGITATION MOTOR 2L (NEW STYLE) - A100/A200/250
A20560	CANISTER COVER ASSY W/ AGITATION MOTOR 2L (OLD STYLE) - A200/250
A10582	CANISTER ASSEMBLY STANDARD FLOW - SOLVENT BASED (EXTREME VITON) - **RARE** - A200/A250
A10581 A20657 (#7)	CANISTER ASSEMBLY STANDARD FLOW 2LTR (NEW STYLE) (VITON) A100-A150-A200-A250
A20500	CANISTER ASSEMBLY STANDARD FLOW 2LTR (OLD STYLE) VITON A200-A250
A10585 A25657 (#7)	CANISTER ASSEMBLY STANDARD FLOW 2.6LTR (FORPRENE) - A210-A260
A10587	CANISTER ASSY HIGH FLOW - 2.6LTR (FORPRENE) A210/A260 Used By: Ace Hardware - If there is an "A" on the end of the model number. Home Hardware - Those with "HB1" on the end of the model number. B Black, C YOX, G White, H Umber use these pumps.
A10594	CANISTER ASSEMBLY STANDARD FLOW 2.6LTR (VITON) (TRUE VALUE ONLY) - A210-A260
A10510	CABLE - USB - DISPENSER TO COMPUTER - 15 FT
A10601	DISPENSE TUBE - PER METER
A10761	FUSE - 10A 5X20 - A200/A250/A450
A10786	MAIN POWER CORD - AC SUPPLY
A10790	HEX KEY WRENCH SET - METRIC
A20143	CAN SHELF - BLACK WITH ALUMINUM TOP - A200/250
A20786	SWITCH - POWER - LIGHTED - A200/A250
A10305	AUTO CAPPER ASSY - SHORT ARM - A200/250 & (450 Before SN 0411-04200)
A10720-EX	MAIN CIRCUIT BOARD - SIMULTANEOUS A150/A160/A250/A260
A20710	MAIN CIRCUIT BOARD - SEQUENTIAL - A100/A200/A210
A10773	POWER SUPPLY - 67V - A200/250/450
A10775	LASER AIMING LIGHT - A200/250/450
A20735	MAIN WIRING HARNESS TO POWER SUPPLY / AUTO CAPPER / AIMING LIGHT / CAN SENSOR
A20745	MAIN WIRING HARNESS TO POWER SUPPLY / AUTO CAPPER / AIMING LIGHT / CAN SENSOR A200-24 ONLY
A20740	AC POWER AND SWITCH WIRING HARNESS ASSEMBLY - A200
A20750	CAN SENSOR ASSEMBLY - A200/250
A20772	POWER SUPPLY - 24V - A200/250
A25740	WIRING HARNESS - MAIN CIRCUIT BOARD TO STEPPER MOTOR & AGITATION MOTOR - A250/260
A10320	HUMIDIFIER PAD (6 PACK)
A10323	HUMIDIFIER PAD (12 PACK)
A10341	HUMIDIFIER PAD HOLDER WITHOUT CAP RING
A10342	CAP RING FOR HUMIDIFIER PAD HOLDER
A10345	HUMIDIFIER PAD HOLDER ASSEMBLY - INCLUDES A10341 & A10342
A10347	MOISTURE SEAL FOR AUTO CAPPER / NOZZLE CLUSTER
A200 / A250 FORPRENE CANISTERS COMPLETE	
A20651	CANISTER & NOZZLE ASSEMBLY - INCLUDES TUBING / FITTINGS / SPRINGS #1 A200-A250

A20652	CANISTER & NOZZLE ASSEMBLY - INCLUDES TUBING / FITTINGS / SPRINGS #2 A200-A250
A20653	CANISTER & NOZZLE ASSEMBLY - INCLUDES TUBING / FITTINGS / SPRINGS #3 A200-A250
A20654	CANISTER & NOZZLE ASSEMBLY - INCLUDES TUBING / FITTINGS / SPRINGS #4 A200-A250
A20655	CANISTER & NOZZLE ASSEMBLY - INCLUDES TUBING / FITTINGS / SPRINGS #5 A200-A250
A20656	CANISTER & NOZZLE ASSEMBLY - INCLUDES TUBING / FITTINGS / SPRINGS #6 A200-A250
A20657	CANISTER & NOZZLE ASSEMBLY - INCLUDES TUBING / FITTINGS / SPRINGS #7 A200-A250
A20658	CANISTER & NOZZLE ASSEMBLY - INCLUDES TUBING / FITTINGS / SPRINGS #8 A200-A250
A20659	CANISTER & NOZZLE ASSEMBLY - INCLUDES TUBING / FITTINGS / SPRINGS #9 A200-A250
A20660	CANISTER & NOZZLE ASSEMBLY - INCLUDES TUBING / FITTINGS / SPRINGS #10 A200-A250
A20661	CANISTER & NOZZLE ASSEMBLY - INCLUDES TUBING / FITTINGS / SPRINGS #11 A200-A250
A20662	CANISTER & NOZZLE ASSEMBLY - INCLUDES TUBING / FITTINGS / SPRINGS #12 A200-A250
A20663	CANISTER & NOZZLE ASSEMBLY - INCLUDES TUBING / FITTINGS / SPRINGS #13 A200-A250
A20664	CANISTER & NOZZLE ASSEMBLY - INCLUDES TUBING / FITTINGS / SPRINGS #14 A200-A250
A20665	CANISTER & NOZZLE ASSEMBLY - INCLUDES TUBING / FITTINGS / SPRINGS #15 A200-A250
A20666	CANISTER & NOZZLE ASSEMBLY - INCLUDES TUBING / FITTINGS / SPRINGS #16 A200-A250
A210 / A260 FORPRENE CANISTERS COMPLETE	
A25651	CANISTER & NOZZLE ASSEMBLY - INCLUDES TUBING / FITTINGS / SPRINGS #1 A210-A260
A25652	CANISTER & NOZZLE ASSEMBLY - INCLUDES TUBING / FITTINGS / SPRINGS #2 A210-A260
A25653	CANISTER & NOZZLE ASSEMBLY - INCLUDES TUBING / FITTINGS / SPRINGS #3 A210-A260
A25654	CANISTER & NOZZLE ASSEMBLY - INCLUDES TUBING / FITTINGS / SPRINGS #4 A210-A260
A25655	CANISTER & NOZZLE ASSEMBLY - INCLUDES TUBING / FITTINGS / SPRINGS #5 A210-A260
A25656	CANISTER & NOZZLE ASSEMBLY - INCLUDES TUBING / FITTINGS / SPRINGS #6 A210-A260
A25657	CANISTER & NOZZLE ASSEMBLY - INCLUDES TUBING / FITTINGS / SPRINGS #7 A210-A260
A25658	CANISTER & NOZZLE ASSEMBLY - INCLUDES TUBING / FITTINGS / SPRINGS #8 A210-A260
A25659	CANISTER & NOZZLE ASSEMBLY - INCLUDES TUBING / FITTINGS / SPRINGS #9 A210-A260
A25660	CANISTER & NOZZLE ASSEMBLY - INCLUDES TUBING / FITTINGS / SPRINGS #10 A210-A260
A25661	CANISTER & NOZZLE ASSEMBLY - INCLUDES TUBING / FITTINGS / SPRINGS #11 A210-A260
A25662	CANISTER & NOZZLE ASSEMBLY - INCLUDES TUBING / FITTINGS / SPRINGS #12 A210-A260
A25663	CANISTER & NOZZLE ASSEMBLY - INCLUDES TUBING / FITTINGS / SPRINGS #13 A210-A260
A25664	CANISTER & NOZZLE ASSEMBLY - INCLUDES TUBING / FITTINGS / SPRINGS #14 A210-A260
A25665	CANISTER & NOZZLE ASSEMBLY - INCLUDES TUBING / FITTINGS / SPRINGS #15 A210-A260
A25666	CANISTER & NOZZLE ASSEMBLY - INCLUDES TUBING / FITTINGS / SPRINGS #16 A210-A260