

corob

# COROB TATOCOLOR

Automatic Dispenser  
User's Manual



© 2008 COROB S.p.A.

User's Manual

*Automatic Dispenser*

*COROB TATOCOLOR*

Version 1.0 – R\* (0, /2008)

TRANSLATION OF THE ORIGINAL INSTRUCTIONS

© COPYRIGHT 2008, COROB S.p.A.

All rights reserved in all countries. If you require additional copies of this manual or further technical information about it, please write to:

**COROB S.p.A.**

**Via Agricoltura 103 • 41038 San Felice s/P • Modena • Italy**

**Phone: +39-0535-663111 • Fax: +39-0535-663285**

**Web site: [www.corob.com](http://www.corob.com) - Email: [info.it@corob.com](mailto:info.it@corob.com)**

**INTELLECTUAL PROPERTY RIGHTS AND DISCLAIMER**

No part of this manual may be translated into any other languages and/or adapted and/or reproduced in any form, or by any means, electronic or mechanical, including but not limited to photocopying and recording, without prior written permission of COROB S.p.A..

COROB is a registered trademark and/or commercial trademark used on an exclusive basis by COROB S.p.A. and its affiliated companies (hereinafter "COROB").

A failure of a trademark to appear hereunder does not mean that COROB does not use the trademark in question nor does it constitute a waiver by COROB of any related intellectual property rights.

Valuable proprietary technical information contained in the present manual are referring to proprietary know-how, designs, drawings and/or applications used on an exclusive basis by COROB frequently covered by Patents and/or Patent Applications and thus protected by International and National Intellectual Property Laws.

Unless otherwise indicated, all references to other companies other than COROB and its affiliated companies, their names, data and addresses used in the screens and/or examples are purely coincidental and serve as a reference only to clarify the use of the COROB products.

COROB has carefully reviewed the wording and images contained in the present manual, nevertheless COROB reserves the right to modify and/or update the information herein to correct editorial errors and/or inaccuracy of the information herein without notice or commitment on its part.

The present manual contains all information necessary for the foreseeable and normal use of the COROB products by the final user.

The manual does not contain guidelines and/or information for product repair. For safety reasons, only trained and authorized technical personnel should perform such interventions. Failure to do so may result in personal injury or damage to the product.

For the purpose mentioned above, COROB has appointed authorized technical personnel.

Authorized technical personnel shall mean technicians who have attended a technical training course held by COROB and/or its affiliated companies.

Unauthorized interventions could void the warranty coverage of your COROB product pursuant to the sales contract or to the General Sales Conditions of COROB. COROB can be held responsible only within the limits of the warranty coverage provided by the General Sales Conditions.

COROB does not intend to limit or exclude its liability against any statutory provisions under any applicable law. Therefore the reference to above warranty limitations or exclusions may not apply.

The final user can ask COROB or visit the web site [www.corob.com](http://www.corob.com) for contact details about the nearest authorized technical service.

# CONTENTS

---

1.1	Purpose and use of this manual.....	1-1
1.2	Conventionally used graphics.....	1-1
2.1	General safety warnings.....	2-1
2.2	Residual risks.....	2-2
2.3	Position of labels.....	2-4
2.4	Identifying information.....	2-5
2.5	Warranty.....	2-6
2.6	Definitions.....	2-7
	2.6.1 Operator - Machine interaction.....	2-7
	2.6.2 Personnel qualifications.....	2-7
2.7	Fire extinguishing means to be used.....	2-7
2.8	Declaration of conformity.....	2-7
3.1	General description.....	3-1
	3.1.1 COROB TATOCOLOR TB.....	3-1
	3.1.2 COROB TATOCOLOR TA.....	3-2
3.2	Description of groups.....	3-2
	3.2.1 Canister section.....	3-2
	3.2.2 Dispensing section.....	3-3
	3.2.3 Shelf for can positioning.....	3-4
	3.2.4 Humidifier cap.....	3-5
	3.2.5 Punch & plugger - TATOCOLOR TA only.....	3-6
3.3	Technical specifications.....	3-7
3.4	Performance and characteristics of the machine.....	3-8
3.5	Cans to be handled.....	3-8
	3.5.1 COROB TATOCOLOR TB.....	3-9
	3.5.2 COROB TATOCOLOR TA.....	3-9
3.6	Minimum computer requirements.....	3-9
3.7	Intended and improper use.....	3-9
3.8	Safety devices.....	3-10
4.1	General warnings.....	4-1
4.2	Moving and handling the packed machine.....	4-1
4.3	Environment conditions of the installation site.....	4-1
4.4	Unpacking and placement.....	4-2
4.5	Moving and handling the unpacked machine.....	4-5
4.6	Storage.....	4-5
4.7	Product disposal and recycling.....	4-6
5.1	General warnings.....	5-1
5.2	Conditions for proper installation.....	5-1
5.3	Installing accessories.....	5-1
	5.3.1 Mounting the support plate for the computer.....	5-1
5.4	Canister filling and first machine startup.....	5-2
	5.4.1 Purge procedure.....	5-2
	5.4.2 Colorant recirculation procedure.....	5-3
5.5	Connecting the computer and installing the software.....	5-3
	5.5.1 Installing the keyboard (only model TB, with sheet metal panels).....	5-5
	5.5.2 Machine configuration through the management program.....	5-5
5.6	Moistening the cap sponge.....	5-5
5.7	Calibration.....	5-6
6.1	General warnings.....	6-1
6.2	Electrical connection and start-up.....	6-1
6.3	Initialization.....	6-3
6.4	Shut-down.....	6-4

7.1	General warnings .....	7-1
7.1.1	<i>Warnings on the use of colorants</i> .....	7-1
7.2	Running COROB TATOCOLOR TB .....	7-1
7.2.1	<i>Positioning/loading cans</i> .....	7-1
7.2.2	<i>Dispensing</i> .....	7-2
7.3	Running COROB TATOCOLOR TA .....	7-3
7.3.1	<i>Positioning/loading cans</i> .....	7-3
7.3.2	<i>Punching the can lid</i> .....	7-3
7.3.3	<i>Dispensing</i> .....	7-4
7.3.4	<i>Inserting the plastic plug on the can lid</i> .....	7-4
7.4	Automatic timed processes .....	7-5
7.5	Refilling the canisters .....	7-6
8.1	General warnings .....	8-1
8.1.1	<i>Warnings on the use of colorants</i> .....	8-1
8.2	Maintenance table .....	8-2
8.3	Cleaning .....	8-2
8.3.1	<i>External cleaning (dispenser)</i> .....	8-2
8.3.2	<i>Cleaning the nozzle center</i> .....	8-2
8.4	Moistening the humidifier cap sponge.....	8-3
8.5	Checking and replacing the punch tool (model TA) .....	8-5
8.5.1	<i>Using the punch tool screwing/unscrewing device</i> .....	8-5
8.6	Filter maintenance .....	8-6
9.1	General warnings .....	9-1
9.2	Connecting the service computer.....	9-1
10.1	Introduction .....	10-1
10.2	Using VOC-free colorants .....	10-1
10.2.1	<i>Operating conditions</i> .....	10-1
10.2.2	<i>Filling and refilling</i> .....	10-1
10.2.3	<i>Daily cleaning</i> .....	10-1
10.2.4	<i>Humidifying cap / Nozzle washer</i> .....	10-1
10.3	Used dispenser by solvent-free colorants .....	10-2
10.4	What to do in case of a microbial contamination?.....	10-2
11.1	Laser equipment safety.....	11-1
11.2	Position of labels.....	11-1

# 1 INTRODUCTION

---

## 1.1 Purpose and use of this manual

---

This manual, inserted in the product packing, contains instructions on the installation, use, and routine maintenance of the following equipment:

Automatic dispenser, model **COROB TATOCOLOR**

This manual provides instructions on the routine maintenance needed to uphold the machine's performance over time.

It is aimed at the machine operators and installers, who must have the necessary training and professional skill to use similar automatic machines.

It also contains all information available at the time of publication regarding the machine and accessories; since the latter are optional, they may not be installed on your machine. It thus also includes any variations or changes that involve different operating procedures for either the installation technician or the operator.

### **Read this manual carefully before installing and using the machine.**

This manual is organized into chapters, each of which refers to a specific topic.

The manual is to be considered an integral part of the machine, and must be stored until it is fully dismantled.

We recommend that you store it close to the machine so that it is easily accessible, in a place protected from heat and damp.

Use the manual in such a way as to avoid damaging its contents; do not remove, tear, or rewrite any portion of its contents.

Should it be lost or partially ruined, so that its contents can no longer be read in full, we recommend that you request a new manual from the manufacturer.

Give this manual to any other user or subsequent owner of the machine.

**Some of the illustrations in this manual were taken from prototypes; some details may differ on machines in standard production.**

## 1.2 Conventionally used graphics

---

The following graphics will be used in this manual to highlight special precautions or important suggestions for safety purposes and for operating the machine properly.



**WARNING / DANGER** - Indicates a risk of personal injury.



**CAUTION / IMPORTANT** - Indicates a risk of damage to the machine that could interfere with its operation.



This symbol indicates important instructions referring to precautionary rules and/or measures to adopt.



This symbol indicates those operations that must be carried out solely by qualified or appropriately trained personnel.



This symbol indicates situations and/or operations that involve the management application program installed on the computer.

**Boldface** type is used to highlight notes or information of particular importance to a topic.

## 2 GENERAL INFORMATION

---

### 2.1 General safety warnings

---

This COROB dispenser has been designed and manufactured in observance of essential safety requirements; the CE marking certifies its compliance.

All measures and precautions were taken during its design, manufacture, testing and installation to ensure the highest possible level of safety considering rational use of the machine.

 The warnings listed below are to be considered general in nature; specific safety instructions related to the type of intervention to be carried out and the type of accessories installed on the machine are given in detail in the specific paragraphs.

#### READ THE SAFETY WARNINGS CAREFULLY BEFORE USING THE MACHINE



### WARNINGS



- Do not perform any type of work on the machine before you have read and understood the instructions in this manual.
- Pay close attention to the warning signs on the machine.
- It is strictly forbidden to bypass or disable the protections and any safety devices present on the machine.
- **THE MACHINE IS NOT EXPLOSION-PROOF AND MUST NOT BE USED IN AREAS AT RISK FOR EXPLOSION.**
- The machine must be used only for its intended purpose.
- The machine is suitable for use with tinting products in general. Scrupulously follow the safety precautions and the instructions for use given on the colorant package and on the safety data sheet supplied by the manufacturer. When compulsory, use personal protection equipment for eyes and hands.
- **When using colorants containing volatile solvents, do not use naked flames, electrical tools or other types of devices that could cause sparks or fire hazards close to the machine.**
- The packing must be handled only by skilled personnel using appropriate handling equipment and according to the instructions given in the corresponding chapter.
- During routine maintenance operations, scrupulously follow the safety instructions given in the corresponding chapters before accessing the dangerous area.
- The rear door and panels must be kept closed at all times.
- **Only qualified or appropriately trained personnel are authorized to access the electrical and mechanical parts of the machine for maintenance and repairs.**
- **Unauthorized personnel are forbidden to remove the panels and access the electrical and mechanical parts of the machine.**
- The panels and the rear door are not equipped with safety limit switches; the key to open the panels and rear door must be kept only by the qualified personnel assigned to carry out machine maintenance.
- Always unplug the power supply cable from the socket outlet before carrying out any maintenance operations.
- In the absence of colorant, the machine pumps contain a lubricant oil that could contaminate the colorant in the canisters during the stages of machine installation and first start-up; we therefore urge you to carefully follow the installation instructions when filling the canisters for the first time.

## 2-2 2-GENERAL INFORMATION

- During installation, maintenance and repairs to the machine, any operation that involves direct contact with internal parts must be carried out with the machine off and with the power supply cable unplugged from the socket outlet.
- **Any intervention inside the machine when panels are open and when the machine is powered, must be carried out by qualified or appropriately trained personnel and only when requested in the user's manual.**
- The machine must not be powered by a power source having specifications other than those listed on the identification plate.
- Incorrect grounding may lead to the risk of electrical shock; always plug the machine into a socket that ensures grounding according to current accident prevention regulations.
- The machine is isolated from the power supply line when the power cable is disconnected; it must therefore be installed near an easily accessible mains socket outlet.
- Do not use extension cords to power the machine.
- Do not use multisockets to connect other equipment to the same socket that powers the machine.
- Periodically check the condition of the power supply cable; if it is damaged, replace it with a new cable supplied by the manufacturer.
- Do not remove or make illegible the signs indicating danger, warnings or instructions. Replace any sign which has become illegible or is missing. These signs can be requested to the machine manufacturer.
- In the event of a sudden power outage, when power returns the machine will automatically be switched on to allow the automatic processes to prevent products from drying out.
- In the event of a breakdown on any of the electronic control equipment, replace the damaged equipment immediately; do not attempt to repair the breakdown (for qualified personnel only).
- The substances that may be used on the machine--such as colorants, paints, solvents, lubricants and cleansers--may be hazardous to your health; handle, store and dispose of these substances in keeping with current regulations and the instructions provided with the product.

## 2.2 Residual risks

---

Although all measures and precautions were taken during design, to ensure safe use of the machine, some hazardous situations may occur for which complete elimination of the risk was not possible.

<b>Risk</b>	<b>Preventive measure</b>	<b>Reference in the manual</b>
Crushing caused by the movement of the manual shelf	<ul style="list-style-type: none"><li>– The machine must be used by a single operator</li><li>– Wear appropriate personal protective equipment (gloves)</li><li>– Appropriate personnel training</li></ul>	chapter 7
Crushing during the cans loading and unloading operations	<ul style="list-style-type: none"><li>– Wear appropriate personal protective equipment (shoes and gloves)</li><li>– Appropriate personnel training</li></ul>	chapter 7



<b>Risk</b>	<b>Preventive measure</b>	<b>Reference in the manual</b>
Injuries and abrasions caused by sharp edges and end parts of the cans to be handled	– Wear appropriate personal protective equipment (cut-proof gloves)	chapter 7
Dorsal/lumbar injuries caused by handling of heavy loads	– Appropriate personnel training – Do not exceed the weight limits stated by the current regulations in force (kg 20 for women, kg 30 for men)	chapter 7
Crushing caused by the movements of the manual shelf	– The machine must be used by a single operator – Wear appropriate personal protective equipment (gloves) – Appropriate personnel training	chapter 7
Crushing caused by the movement of the Autocap	– Appropriate personnel training	chapter 7
Injuries during can punching operations	– The machine must be used by a single operator – Keep hands away from the can lid – Wear appropriate personal protective equipment (gloves) – Appropriate personnel training	chapter 7
In case of a power blackout, the timed processes may unexpectedly start when power returns	– Appropriate personnel training – Only trained personnel may intervene in reduced safety conditions	chapter 7 chapter 8
Contact or inhalation of colorants during the canister refilling operations	– Keep the room suitably ventilated – Wear appropriate personal protective equipment (safety goggles, gloves and mask) – Appropriate personnel training	chapter 7
Contact or inhalation of colorants during the cleaning operations of the nozzle center and moistening of the Autocap sponge	– Keep the room suitably ventilated – Wear appropriate personal protective equipment (safety goggles, gloves and mask) – Appropriate personnel training	chapter 8
Crushing during the cleaning operations of the nozzle center	– Appropriate personnel training – Only trained personnel should carry out these operations	chapter 8
Injuries during assembly/disassembly operations of the punch tool	– Wear appropriate personal protective equipment (cut-proof gloves) – Appropriate personnel training – Only trained personnel should carry out these operations	chapter 8

Risk	Preventive measure	Reference in the manual
Crushing or trapping during filter maintenance operations	<ul style="list-style-type: none"> <li>– Appropriate personnel training</li> <li>– Only trained personnel may intervene in reduced safety conditions</li> <li>– Only trained personnel should carry out these operations</li> </ul>	chapter 8
Fire due to the use of colorants containing volatile solvents	– Do not use naked flames, electrical tools or other types of devices that could cause sparks or fire hazards close to the machine	chapter 2.1
	– The room in which the machine is installed must be spacious, with good ventilation (air exchange) and no type of parts must be leant against or stocked close to the machine	chapter 4.3
	– Canister top up must be carried out sequentially, opening one canister at the time. If during this operation, some colorant should spill out of the canister, immediately shut down (electrical stop) the machine before cleaning	chapter 7.5

## 2.3 Position of labels

A warning label is applied on back of the machine (Figure 2-1). The following general warnings are listed on the label:



**1. Read the manual carefully**

Indicates the requirement to consult the instruction manual before carrying out any operation on the machine.



**2. Access prohibited, do not open**

Indicates that unauthorized personnel are forbidden to remove the panels and access the internal components of the machine.



**3. Dangerous voltage**

Indicates that there are live components inside the compartment. Risk of electrocution if you perform any operation inside the compartment without first cutting off electrical power. Before removing the panels, always unplug the power supply cable from the mains socket outlet.

**4. Label "Serial ports"**

Indicates the connection point for the machine management computer (symbol on the right) and the service computer (symbol on the left).



Figure 2-1

The following warning label is applied on the front of the machine, near the dispensing nozzle area (Figure 2-2):

**5. Label "Risk of crushing" (only model TA)**

Indicates the dangerous area during the following phases: punching and plastic plug insertion.



Figure 2-2

**2.4 Identifying information**

The machine has an **identification plate** on the rear door, indicating (Figure 2-3):

1. manufacturer's name
2. CE marking
3. WEEE marking
4. machine model
5. year of manufacture
6. serial number
7. electrical specifications
8. internal codes

 Do not remove or tamper with the identification plate in any way.

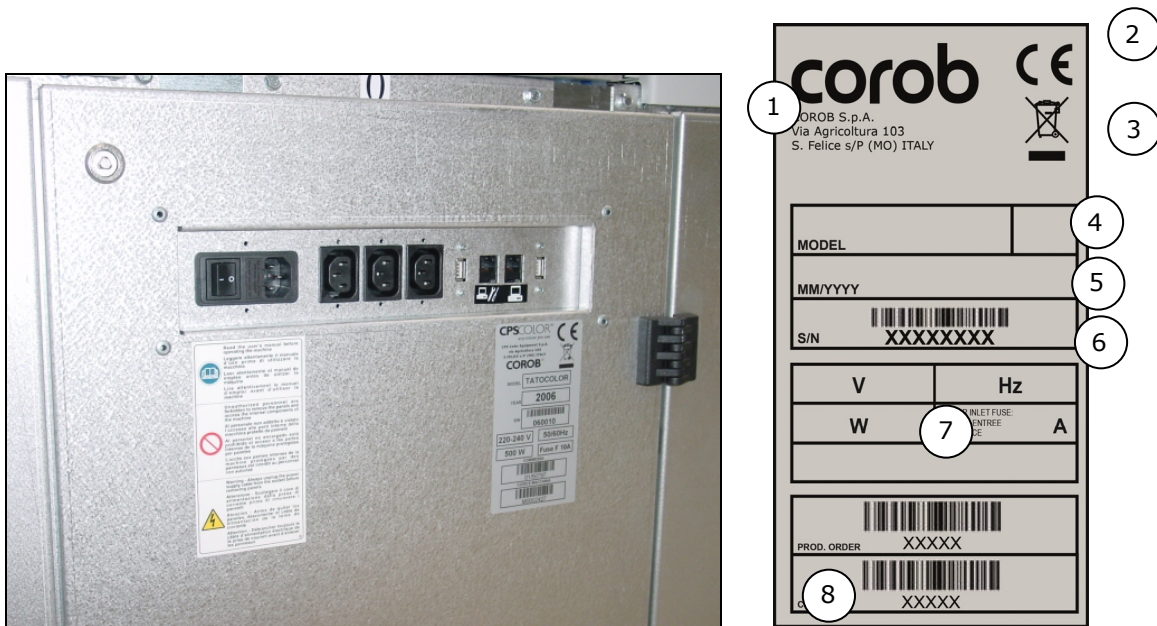



Figure 2-3

## 2.5 Warranty

In order for the warranty to be valid, please complete the form included in the machine packing, and send it to the address listed on the form itself.

 Contact our authorized, qualified personnel only for all your service needs. Use only original spare parts for all maintenance and repairs.



*Altering or removing the guards and safety devices provided on the machine will not only void the warranty immediately, but is also dangerous and illegal. The manufacturer may not be held liable for personal injury or property damage caused by improper use of the equipment or tampering with the guards and safety devices installed on the machine.*

The following shall **void the manufacturer's warranty**:

- improper use of the machine
- failure to observe the instructions and maintenance rules set forth in the manual
- making or having changes and/or repairs made on the machine by personnel outside the service organization authorized by the manufacturer
- making or having changes and/or repairs made using non-original spare parts

**In the event of serious breakdowns, or if the user does not feel it appropriate to intervene directly, contact a service center authorized by the manufacturer.**

## 2.6 Definitions

---

### 2.6.1 Operator - Machine interaction

---

The table below gives a list of operator-machine interactions.

DANGEROUS AREA	This refers to any area inside and/or near the machine in which the presence of an exposed person constitutes a risk to the safety and health of the person.
EXPOSED PERSON	This refers to any person fully or partly located within a dangerous area.
OPERATOR AREA	This is where the operator may be safely located while the machine is running. The operator can control all machine operations from this position.
MACHINE STATUS	Status refers to the operating mode or status of the safety devices installed on the machine.
NUMBER OF OPERATORS	Indicates the number of employees needed to carry out a given function properly. Use of a greater or lesser number of people could make it impossible to achieve the expected results, or be hazardous to the personal safety of the personnel involved.

### 2.6.2 Personnel qualifications

---

Indicates the minimum qualification level according to the table below.

OPERATOR	A person familiar with the use of colorants to produce paints or similar products, assigned to operate and use the machine by its controls and to load and unload production materials with all safety devices enabled. He or she must work only in safety conditions.
MAINTENANCE TECHNICIAN	Specialist prepared and trained in a technical field (mechanical and electrical) and assigned to work on the machine to perform adjustments, repair breakdowns or carry out maintenance.

## 2.7 Fire extinguishing means to be used

---

If the machine catches fire, you must use dry powder or carbon dioxide fire extinguishers. Never use water.

Carefully follow the instructions and warnings indicated by the manufacturer and listed on the extinguisher.

## 2.8 Declaration of conformity

---

See Appendix.

BLANK PAGE

## 3 FEATURES

---

### 3.1 General description

---

The **COROB TATOCOLOR** automatic dispenser allows simultaneous and automatic dispensing (or distribution) of colorants into containers pre-filled with base product, to create paints, dyes, enamels, and inks of the desired hue, chosen by means of the machine management program.

**COROB TATOCOLOR** is a single-unit machine with a maximum of 16 dispensing circuits, divided into three main parts: the central dispensing section, the right side canister section and the left side canister section.

**COROB TATOCOLOR** is available with sheet metal or ABS panels.

The dispenser is fully managed by a normal personal computer. The manufacturer supplies a wide range of software applications to manage all of the machine's functions.

The computer may be supplied upon request.

**COROB TATOCOLOR** is available in two models:

- **COROB TATOCOLOR TB**
- **COROB TATOCOLOR TA**

#### 3.1.1 COROB TATOCOLOR TB

---

COROB TATOCOLOR model TB is equipped with manual shelf and humidifier cap (sliding cap or automatic sliding cap). The machine is made up of (Figure 3-1):

1. Central dispensing section
2. Right side canister section
3. Left side canister section

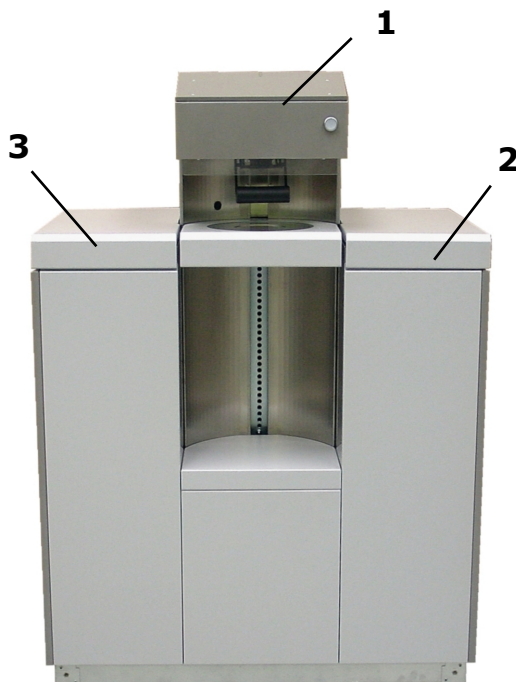

Figure 3-1 - COROB TATOCOLOR with sheet metal panels - model TB

## 3-2 3-FEATURES

The machine may be accessorized with an optional device to center the hole of the pre-punched can under the nozzle center with a laser (Bung hole locator or B.H.L.), this is useful for those using pre-punched cylindrical or differently shaped cans.

The structure of the dispensing section has been designed to allow the computer, monitor and keyboard to be housed on the machine. An auxiliary support plate for the computer may be requested as an optional.

### 3.1.2 COROB TATOCOLOR TA

---

COROB TATOCOLOR model TA is equipped with manual shelf and automatic sliding cap. It also features a manual punch with the possibility to add a manual pluggger, to perforate and apply a plastic plug on the can lids; the dispensing section is higher, and an adjustable arm (optional) can be applied alongside the section with a support plate for the computer, to maintain the machine's ergonomic qualities. The machine is made up of (Figure 3-2):

1. Central dispensing section
2. Right side canister section
3. Left side canister section

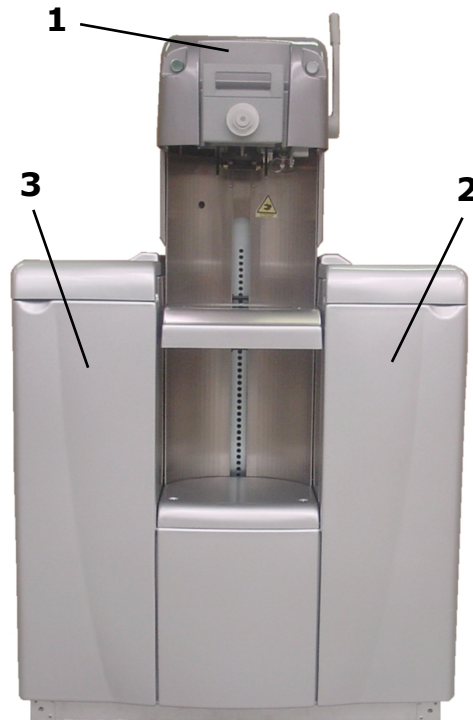

*Figure 3-2 - COROB TATOCOLOR with ABS panels - model TA*

## 3.2 Description of groups

---

This chapter gives a detailed description of the main machine groups.

### 3.2.1 Canister section

---

(Figure 3-3)

The side sections of the machine house canisters (1) suitable for containing the product to be dispensed. To keep the colorant to be dispensed in the best possible condition of storage and homogeneity, each canister is equipped with a stirrer with slanted blades (2), powered by a gear-

## COROB TATOCOLOR



motor (3) attached beneath the canister itself. The materials of which the shaft and stirrer blades are made are compatible with the type of product that the canister is to contain.

At regular, programmable intervals, the management computer activates the stirrers for a programmable time, one after another; the stirring time and interval between cycles may be set based on the physical nature of the products in the canisters.

The rotation speed of the stirrer prevents the formation of air emulsions and other negative effects that could interfere with the machine's performance.

During dispensing, if stirring is in progress it is interrupted to allow suitable working conditions; the stirring cycle will start again at the end of dispensing.

In addition to stirring, recirculation takes place at regular programmable intervals to keep the colorant to be dispensed in ideal condition; this process circulates the colorant, which travels throughout the dispensing circuit and returns to the canister through a special fitting (4).

The canister sections house the COROB pumps (5), made of wear-resistant materials that maintain their characteristics over time. All pumps are driven by a single gear-motor (6) located in the dispensing section.

Each pump has a filtering unit (7) that serves to trap any impurities that may be present in the colorant, protecting the life-span, integrity and precision of the pumps.

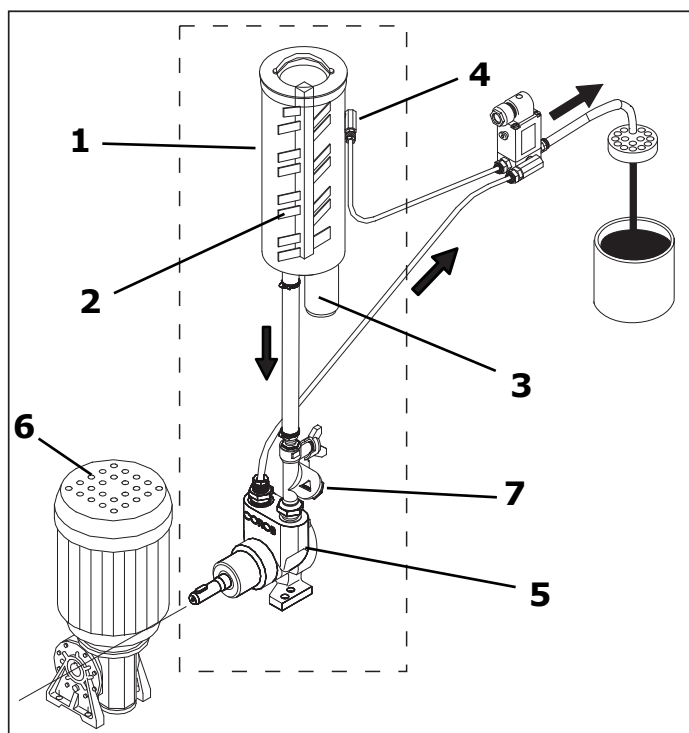

Figure 3-3

### 3.2.2 Dispensing section

(Figure 3-4)

The dispensing section (also called the dispensing center) is where the ends of all of the machine's dispensing circuits (1) converge, fixed to the nozzle center (2), which dispense the calibrated amounts of colorant.

The part including the nozzle center and can positioning area is known as the **dispensing area**.

The upper compartment of the dispensing section contains the same number of electrovalves (3) as circuits installed on the machine, on a single support surface.

The electrovalves are three-way/two-position valves, suitable for handling viscous, abrasive, and chemically aggressive products.

### 3-4 3-FEATURES

The status of the electrovalve determines whether the colorant is discharged (dispensed) or returned to the canister (recirculation).

The lower compartment of the dispensing section also contains the gear motor (4) that drives the pumps, and the control electronics that allow the machine to run at a steady speed during dispensing operations.

Product is prevented from drying in the nozzle center area by a humidifier cap.

The structure of the dispensing section has been designed to allow the computer, monitor and keyboard to be housed on the machine. An auxiliary support plate for the computer may be requested as an optional.

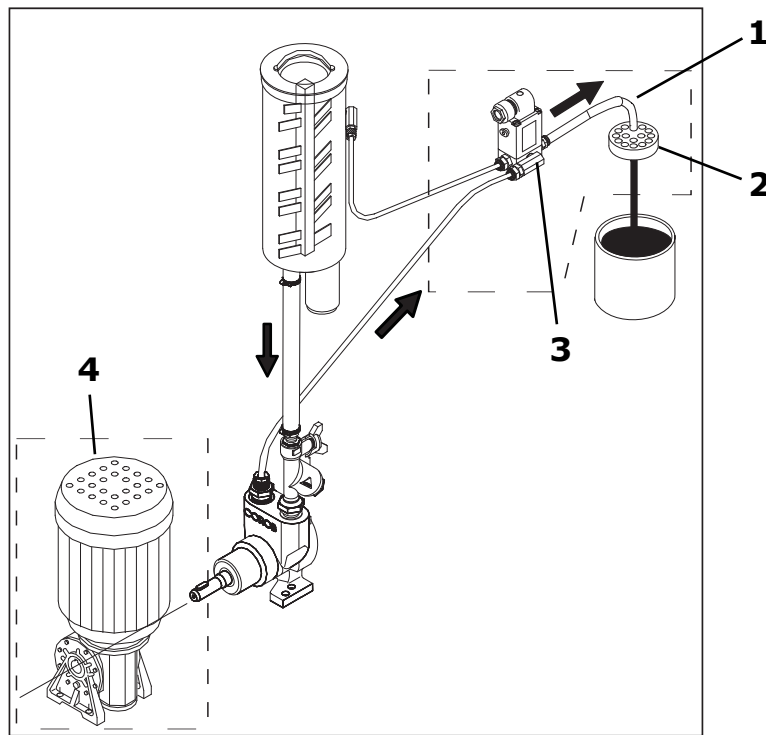

Figure 3-4

### 3.2.3 Shelf for can positioning

COROB TATOCOLOR features an internal dispensing center, which includes the dispensing area and can handling system built into the machine chassis.

The shelf is a system that allows to raise the can and place it correctly in correspondence with the dispensing nozzles.

The cans, of different sizes, containing the base product to be colored are loaded and positioned by a manual shelf (1) (Figure 3-5) fixed to the machine that can be raised or lowered by the operator.

The shelf is provided with a locking handle (3) (Figure 3-6) that must be pulled to release the shelf and allow it to be moved to the desired height. Once you have reached the desired height, release the handle to lock the shelf in place, allowing you to rest the can on it.

The check of can presence is carried out by the photocell (2) (Figure 3-5), placed at the appropriate height in the dispensing area (only when automatic sliding cap is present).

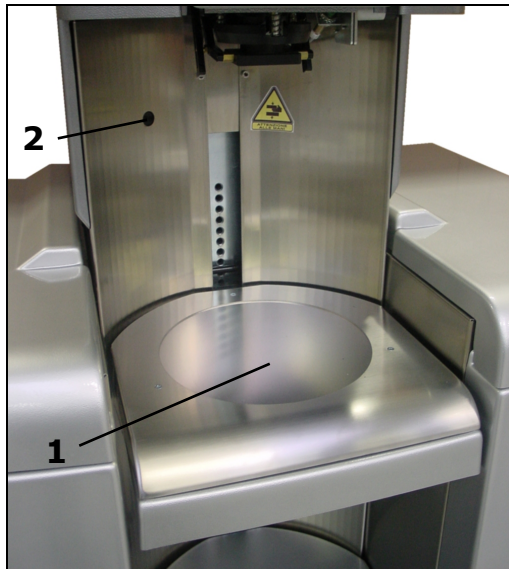

Figure 3-5

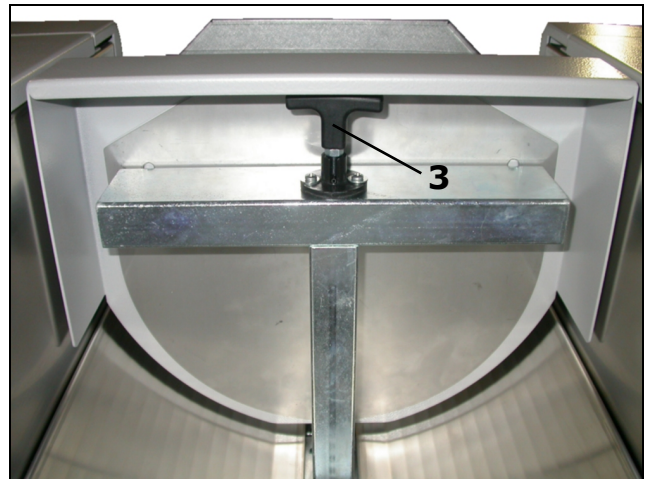

Figure 3-6

### 3.2.4 Humidifier cap

By their very nature, colorants tend to dry out; this tendency may be more or less strong depending on the type of colorant and the environment conditions where the dispenser is installed, such as the temperature, relative humidity, etc.

The machine is equipped with a humidifier cap to keep the dispensing nozzle center at a moisture level to prevent the colorant from drying out; this device contains a moistened sponge.

The sponge is housed inside the cap, and must be cleaned and moistened periodically (chapter 8.4).

#### **Sliding cap**

(Figure 3-7)

This is a simple cap, which opens thanks to the push applied to the opening bar while the can is being positioned; the cap closes when the can is removed. Dispensing is allowed only if the can is present, that is to say when the cap is properly open.

#### **Automatic sliding cap or sliding Autocap**

(Figure 3-8)

This is an automatically activated cap (Autocap) which opens automatically when the can placed on the shelf obscures the photocell, and closes automatically when the shelf is lowered and the photocell disengaged or when the can is removed from the shelf.

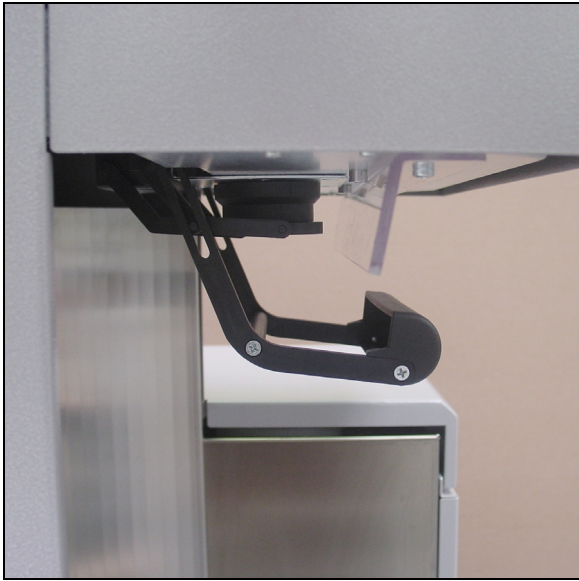

Figure 3-7

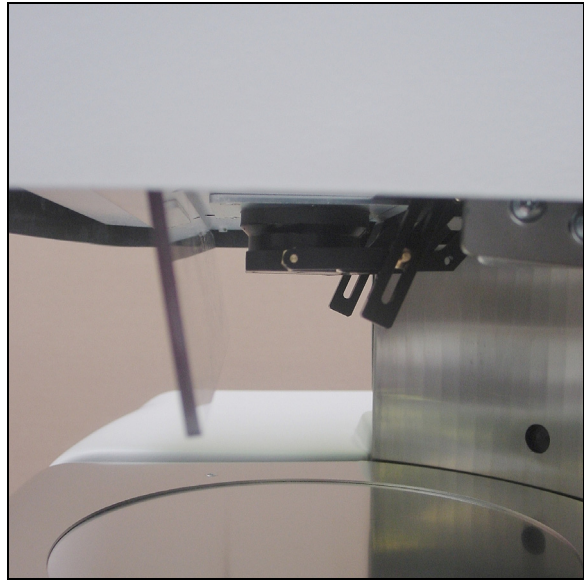

Figure 3-8

### **3.2.5 Punch & plugger - TATOCOLOR TA only**

The punch & plugger is a device that perforates the can lid, then (after dispensing) inserts a plastic plug in the hole made.

On the machine accessorized with the punch, a **can centering device** (custom-made) can be mounted as an optional accessory on the shelf surface, essential for aligning the cans with the nozzle center, so that the can lid is punched in the middle, dispensing precisely into the hole created, and correctly inserting the plastic plug. The can centering device is also available as an optional accessory to the standard machine.

#### **Manual punch**

(Figure 3-9)

The operator punches the can manually, by pulling on the suitable lever (2) that lowers down the manual punch (3); this requires that the enabling button (1) be simultaneously pressed, for obvious safety reasons (chapter 7.3.2). Punching is allowed only if a can has been correctly loaded into the machine.

#### **Manual plugger**

(Figure 3-9)

The plastic plug is inserted by pulling on the suitable lever (2) that lowers down the manual plugger (4); this requires that the enabling button (1) be simultaneously pressed, for obvious safety reasons (chapter 7.3.4). The plug insertion is allowed only if a can has been correctly loaded into the machine.

The green enabling button  (1) is active (and can therefore release the punch/plugger lever) only if it is illuminated, that is when the following conditions occur: correct positioning of the can and opening of the sliding Autocap.

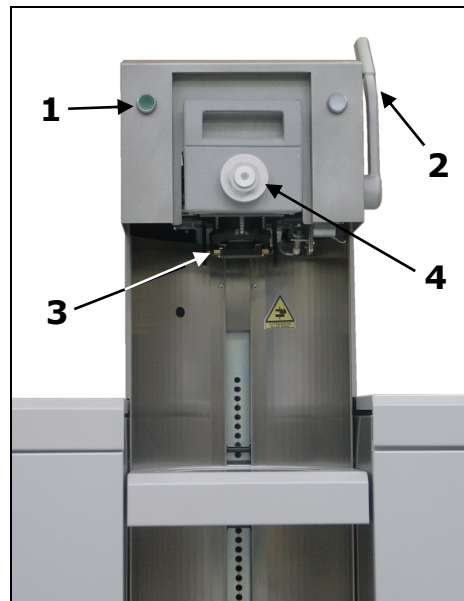

Figure 3-9

### 3.3 Technical specifications

	COROB TATOCOLOR TB	COROB TATOCOLOR TA
<b>ELECTRICAL SPECIFICATIONS</b>		
Power supply*	Single-phase 220 - 240 V~ Single-phase 100 - 110 V~ Other power supplies available upon request	
Frequency	50/60 Hz	
Fuses**	F 10 A	
Maximum power absorbed**	500 W	
<b>NOISE LEVEL</b>		
Level of equivalent acoustic pressure	< 70 dB(A)	
<b>ENVIRONMENT WORKING CONDITIONS***</b>		
Temperature	from 10°C to 40°C	
Relative humidity	from 5% to 85 % (without condensation)	
<b>OVERALL DIMENSIONS</b>		
<i>COROB TATOCOLOR with sheet metal panels</i>		
Length	950 mm	
Depth	600 mm	
Height	1363 mm	1620 mm
<i>COROB TATOCOLOR with ABS panels</i>		
Length	966 mm	
Depth	675 mm	
Height	1368 mm	1620 mm

\* Tolerance  $\pm 10\%$

\*\* Not including connected auxiliary devices. The power information is purely indicative, and depends strictly on the machine configuration.

\*\*\* The climatic working conditions are strictly based on the type of colorants used (ask for information from the paint manufacturer). The data shown are valid for the machine only.

	COROB TATOCOLOR TB	COROB TATOCOLOR TA
<b>WEIGHT*</b>		
<i>COROB TATOCOLOR with sheet metal panels</i>		
Total machine	208 kg	229 kg
Total packed machine	250 kg	271 kg
<i>COROB TATOCOLOR with ABS panels</i>		
Total machine	197 kg	211 kg
Total packed machine	239 kg	253 kg
<b>VIBRATIONS</b>		
The machine does not transmit vibrations to the floor that may compromise the stability and precision of any nearby equipment.		

\* Data are purely indicative, and depend on the exact configuration of the machine and on the number of circuits. The data refer to the machine with the canisters empty.

### 3.4 Performance and characteristics of the machine

	COROB TATOCOLOR TB	COROB TATOCOLOR TA
<b>Dispensing system</b>	volumetric - simultaneous	
<b>Dispensing center</b>	internal	
<b>Number of circuits</b>	up to 16	
<b>Canister capacity</b>	3 liters	
<b>Type of canisters</b>	all-purpose (POM acetalic resin)	
<b>Type of electrovalves</b>	COROB for all-purpose use	
<b>Type of pumps</b>	with internal gears	
<b>Standard circuit flow rate (theoretical at 100 RPM)</b>	0.5 l/min	
<b>Minimum dispensed quantity</b>	1/384 fl oz (0.077 ml)	
<b>Standard accuracy</b>	± 1%	
<b>LAB circuit (optional)</b>	theoretical flow rate at 100 RPM 0.161 l/min	
<b>Nozzle center flow diameter*</b>	31 mm	
<b>Shelf</b>	manual	
<b>Humidifier cap</b>	sliding cap (standard) sliding autocap (optional)	sliding autocap (standard)
<b>Punch</b>	\	manual (standard)
<b>Plugger</b>	\	manual (optional)
<b>Punch diameter</b>	\	46 mm or 55 mm

\* If the cans are pre-punched, the hole diameter must be as follows: flow diameter + 15 mm.

### 3.5 Cans to be handled

The particular structure and ergonomics of the COROB TATOCOLOR automatic dispenser make it suitable for handling small, medium-sized, and occasionally large cans.

The minimum and maximum dimensions of usable cans depend entirely on the type of accessories with which the dispenser is equipped (humidifier cap, punch, plugger, etc.); the overall dimensions of usable cans therefore depend on the machine configuration.

### 3.5.1 COROB TATOCOLOR TB

	with sliding cap		with sliding autocap	
	sheet metal	ABS	sheet metal	ABS
<b>Min height</b>	75 mm	60 mm	35 mm	20 mm
<b>Max height</b>	505 mm	490 mm	490 mm	475 mm
<b>Max diameter (with hole in the center)</b>	230 mm			
<b>Max diameter (with hole not in the center)</b>	340 mm			

### 3.5.2 COROB TATOCOLOR TA

	with sliding autocap	
	sheet metal	ABS
<b>Min height</b>	75 mm	60 mm
<b>Max height</b>	575 mm	560 mm
<b>Max diameter (with hole in the center)</b>	310 mm	
<b>Max diameter (with hole not in the center)</b>	340 mm	

## 3.6 Minimum computer requirements

The minimum computer requirements needed to manage the machine depend entirely on the application software used.



See the program manual for a list of the minimum computer requirements.

In any case, the computer **must have at least two serial ports** (RS232 or USB), needed to communicate with the dispenser and connect the calibration scale (the type of serial port depends on the scale type).

## 3.7 Intended and improper use

The automatic dispenser is a device to automatically and simultaneously dispense (or distribute) fluid colorant products into containers (metal or plastic canisters, cans or bins) of the size indicated in chapter 3.5, pre-filled with base, to produce finished products such as paints, dyes, enamels, and inks of the desired hue.





*The machine must be used only within the limitations set forth by the technical specifications and according to the procedures described in this manual.*

*Any use other than that stated, which cannot be implied or deduced from this manual, is to be considered prohibited.*

## 3.8 Safety devices



*In the event of a breakdown of the safety devices, it is forbidden to use components not provided by the manufacturer. In case of need, contact only the service organization authorized by the manufacturer.*

Device	Description	Operation	TB	TA
 Enabling button for the punch (Figure 3-9)	Green illuminated button located frontally, on the dispensing section	 Button that enables an electromagnet to free the punch lever when pressed, and prevents the punch lever from being lowered when released. Only the lever returns to its original position when the button is released.  If pressed when the sliding autocap is closed, this will cause the autocap to open. It will close back when the button is released.		X



## 4 SHIPPING, HANDLING AND UNPACKING

### 4.1 General warnings

*To avoid personal injuries and property damage, use the utmost care and caution when handling the machine, and carefully follow the instructions given in this chapter.*



*The packing must be handled only by skilled personnel using appropriate handling equipment. Never move the packing by hand or with inappropriate means, to avoid personal injury or breaking the machine.*

*Make sure no one is in the vicinity during those unpacking operations that involve cutting or removing binding systems using hazardous instruments.*

### 4.2 Moving and handling the packed machine

The machine is carefully packed and prepared for shipping, firmly fastened to a sturdy wooden base (pallet), covered externally with a wooden crate or cardboard box, and wrapped with bubble plastic, cellophane, special corrosion-proof paper, etc., depending on the type and duration of shipping planned for delivery.

The dimensions of the packing are the following:

Length (mm)	Depth (mm)	Height (mm)	Weight of the packed machine (kg)	Weight of the packing (kg)
1050	770	1960	see technical specifications	42

Use appropriate lifting equipment (lift truck with flat forks) to lift, handle and/or move the packed machine, as follows.



Note the total weight of the packed machine as marked on the outer packing.

Position and space the lift forks to insert them into the pallet. Insert the forks into the slots provided on the pallet, lift the packing, handle and move as needed, and carefully position it near the installation site.

### 4.3 Environment conditions of the installation site

Environment requirements for the site where the machine is to be installed.

- Clean and dust-free.
- A level, stable floor.
- Fitted with a grounded power supply socket.
- Ventilated to prevent the concentration of harmful fumes.
- Equipped with sufficient lighting. The machine workplace must be equipped with devices that allow adequate artificial light, to protect the operator's health and safety. The room lighting must therefore ensure good visibility from every point of the machine.



*When using **colorants containing volatile solvents** the room in which the machine is installed must be spacious, with good ventilation (air exchange) and no type of parts must be leant against or stocked close to the machine.*

The environment working conditions of the machine must meet the following requirements:

## 4-2 4-SHIPPING, HANDLING AND UNPACKING

- Temperature between 10°C and 40°C
- Relative humidity: from 5% to 85 % (without condensation)

 The climatic working conditions may vary according to the type of colorants used. The proper values are provided by the paint manufacturer or indicated on the colorant package and safety data sheet. The climatic conditions listed above are valid for the machine only.



*Environment conditions outside the values indicated may cause serious damage to the machine, especially the electronic equipment.*

 The area called the **operator area** (border area around the machine) must remain as dry as possible and free of obstacles.

When positioning the machine, observe the distances shown in Figure 4-1.

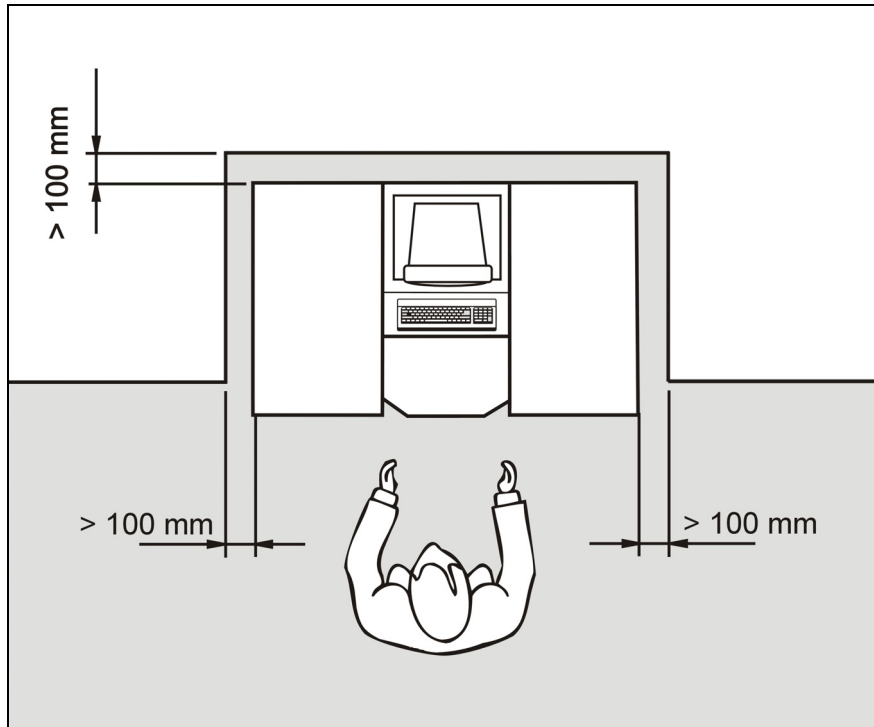

Figure 4-1

## 4.4 Unpacking and placement

Make sure the packing has not suffered any damage or tampering during shipping; if so, contact the authorized technical service or your dealer.

We recommend that you store the packing material for future use, or dispose of it according to current regulations. In any case, we recommend that you keep it for the entire duration of the machine warranty.

To unpack the machine, follow the instructions below:

1. Cut the plastic straps wrapped around the packing (cardboard box only).
2. Remove the covering from the pallet, also removing the corresponding fasteners.
3. Any accessories ordered may be inserted in the packing and packed separately, such as: computer and monitor in their original packing, etc.. Remove all individually packed accessories and set them aside for installation.
4. Remove the bubble plastic and/or cellophane wrapped around the machine.



*Make sure the machine has not been damaged during shipping; if so, do not attempt to start it. Contact the authorized technical service or dealer immediately.*

Inside the packing you will find the material supplied:

- power supply cable
- computer/machine RS232 serial communication cable
- computer power cables
- a kit of spare fuses
- panel key and screwdriver
- sponges and, if necessary, spare holding lid for the humidifier cap
- user's manual
- CE declaration of conformity and installation and warranty start form
- equipment software tools standard CD

Depending on the machine model and/or the options specified on the purchase order, you may also find:

- management program with corresponding user's manual and protection key
- device for screwing/unscrewing punch tool with a manual plugger

Make sure that all of the above items are included in the packing; if not, contact the manufacturer.

The machine is firmly attached to the pallet by means of two fastening brackets.



**At least 3 people must work together** to remove the machine from the pallet.

To remove the machine from the pallet, lower it to the ground and place it correctly on the installation site, follow the procedure below carefully:

1. Lower both platforms (1) hinged to the pallet, making sure they rest evenly on the floor and that they are well aligned with the pallet surface (Figure 4-2).

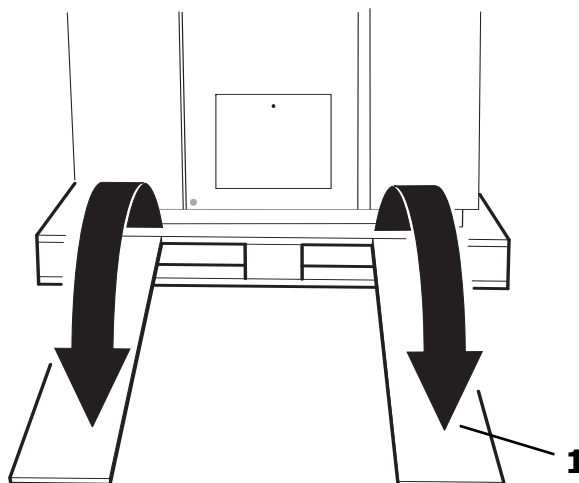

Figure 4-2

2. Slightly loosen the two screws (1) that fix the front bracket to the base of the pallet (Figure 4-3).
3. Remove the side panels of the canister sections.

#### 4-4 4-SHIPPING, HANDLING AND UNPACKING

4. Lower both feet at the front of the machine (see point 12) until the wheels are no longer resting on the pallet surface.
5. Completely unscrew and remove all screws and nuts (1 and 2) that fix the rear bracket to the base of the pallet (Figure 4-3).
6. Operating from the front side, with one person at each corner, tilt the machine frontally until the rear bracket (1) (Figure 4-4) is free and can be removed by a third person.

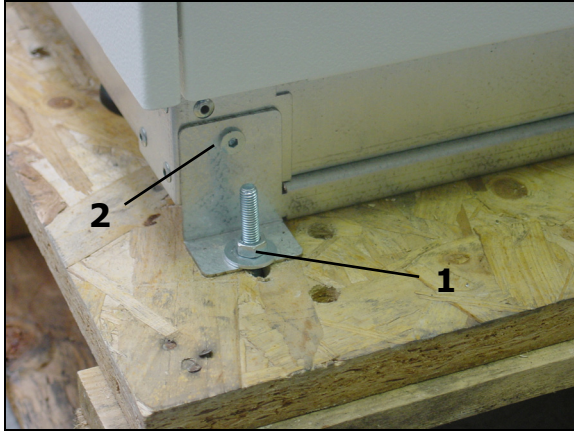

Figure 4-3

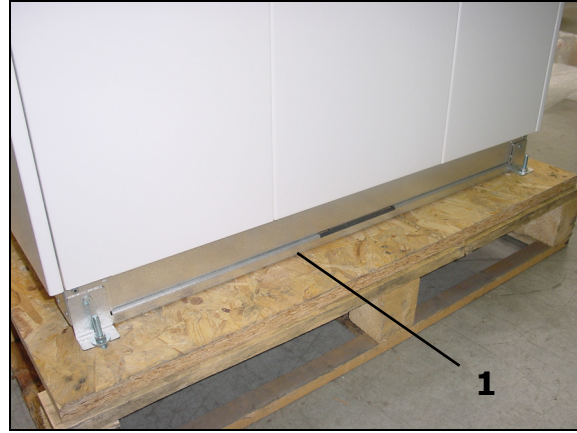

Figure 4-4

7. Completely unscrew and remove all screws and nuts that fix the front bracket to the machine and the pallet.
8. Remove the bracket.
9. Raise the two feet at the front as described in point 12, until the wheels touch the pallet surface.



*The machine must always be lowered to the ground from the pallet using the wheels and special sliding platforms provided; it must never be lifted by hand or dragged in any other manner.*

10. Grasp the machine on the sides as shown in the figure, then slide it slowly along the platforms on its wheels, making sure they remain centered on the platforms, then lower it to the ground (Figure 4-5).

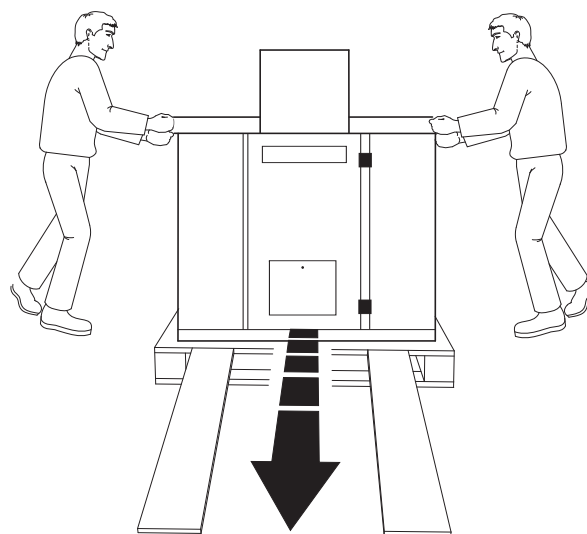

Figure 4-5

11. Place the machine in its working position; the machine support surface must be stable and level. The ideal placement surface is always the floor.

12. At this point, adjust the two front antivibration feet as described below, to support and level the machine properly:

(Figure 4-6/Figure 4-7)

- using a 17 mm hexagonal wrench, loosen the nut (1);
- lower the foot (2) by turning it with your hand until when it touches the resting surface;
- using a 12 mm hexagonal wrench, adjust the hexagonal wrench slot (3) on the foot, to level the machine properly, **and make sure that none of the wheels (4) are resting**;
- using a 17 mm hexagonal wrench, tighten the nut (1) on each foot (2) firmly into the base of the machine.

13. Mount the panels removed previously.

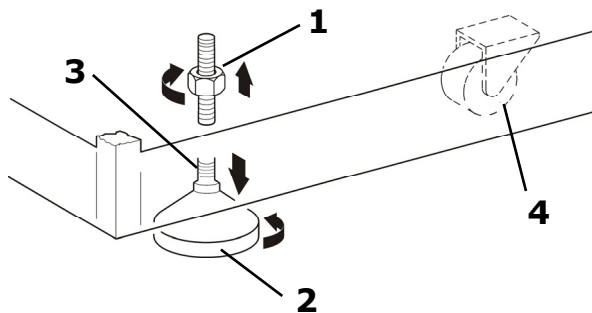

Figure 4-6

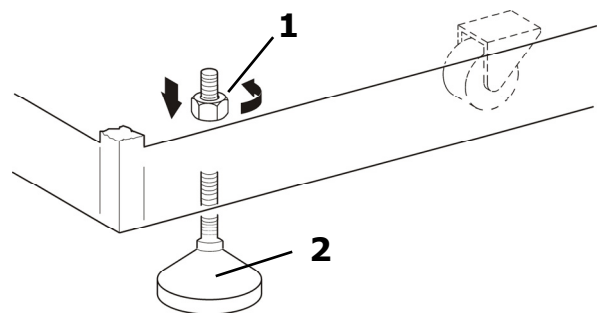

Figure 4-7

## 4.5 Moving and handling the unpacked machine

Should it become necessary for any reason to move the machine from its original site proceed as follows:

1. Use the main switch to shut off the machine, and unplug the power supply cable from the mains socket outlet (chapter 6.4).
2. Using the screwdriver provided, remove the panels near the feet so that you may raise them.
3. Raise **ALL** of the antivibration feet, following the procedure described in point 12 of the previous chapter in reverse order, to move the machine easily on its wheels.
4. Move the machine into its new working position.
5. Lower the feet, following the procedure described in point 12 of the previous chapter.
6. Mount the panels removed previously.
7. Connect the power supply cable and switch on the machine using the main switch (chapter 6.2).

We recommend reusing the original packing any time the dispenser must be moved or shipped.

To place the machine back on the pallet, lift the feet as previously described, grasp the machine on the sides (**this must be done by at least two people**) then slide it slowly along the platforms on its wheels, making sure they remain centered on the platforms.

## 4.6 Storage

If stored, the machine must be kept in a protected, dry environment, not subjected to harsh weather, to avoid damaging the electrical components.



*It is forbidden to stack items on the packing.*

## 4.7 Product disposal and recycling

---

The European Parliament Directive 2002/96/EC, also referred to as the “**WEEE Directive**”, places an obligation on EU-based manufacturers, distributors, retailers and importers of electrical and electronic equipment to integrate the instructions of use of such equipment with information concerning its disposal, re-use, recycling and/or further treatment.

As a main rule, the WEEE Directive requires that the electrical and electronic equipment is disposed of at the end of its useful life in an environmentally responsible manner, so as to enable the re-use or recycling of those parts and materials that have been identified for this purpose.

**It is obligatory not to dispose of Waste Electrical and Electronic Equipment (WEEE) with unsorted municipal waste, and to carry out separate collection.**

Separate collection is the precondition to ensure specific treatment and recycling of the WEEE and the crossed-out wheeled bin symbol on the equipment label - as repeated here below - indicates this requirement.

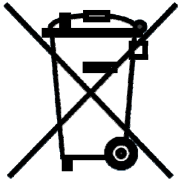

Pursuant to the WEEE Directive, collection, treatment, recovery and environmentally sound disposal of WEEE from users of products containing electrical and electronic equipment put on the market after the 13th of August 2005, shall be carried out in compliance with the national measures of each EU-Member State implementing the WEEE Directive.

For more information about proper disposal and recycling of your COROB product, please contact [info.it@corob.com](mailto:info.it@corob.com).

 If any colorants have been used on the machine that require special disposal procedures, follow local regulations for the colorants remaining in the canisters and for those machine components most soiled with colorant.

## 5 INSTALLATION (by qualified personnel)

---

### 5.1 General warnings

---



Only qualified or appropriately trained personnel are authorized to install the machine.



*Before installing the machine, read the instructions in this chapter carefully to ensure the safety of the personnel involved and avoid damaging the machine.*

Once the machine has been unpacked and placed in its operating site, it must be installed.

### 5.2 Conditions for proper installation

---

You must observe the environment conditions described in chapter 4.3.

You must also prepare an electrical power line in accordance with the voltage and frequency required by the machine, listed on the identification plate (chapter 2.4).

The line must be protected from overloads, short-circuits and direct contacts according to current regulations.



*Check the grounding of the power supply system as required by local regulations before installing or powering the machine.*

Installing a COROB dispenser involves:

- installing any accessories
- filling the canisters and purging the circuits to eliminate lubricant from the pumps
- connecting the computer to the machine and installing the application software
- configuring the machine via the management program
- moistening the sponge in the humidifier cap

### 5.3 Installing accessories

---

Standard and optional accessories are normally pre-installed on the machine. Only in certain situations do they need to be installed.

#### 5.3.1 Mounting the support plate for the computer

---

Proceed with the installation as follows:

1. Unpack the support plate for the computer, by removing the bubble plastic wrapping.
2. Using a 13 mm hexagonal wrench, remove the screw and washer (1) of the pin (2) located on the arm fixed to the machine, so as to insert the computer support plate (Figure 5-1).
3. Insert the support plate in the pin.
4. To fix the support plate to the arm, fit back the screw and washer previously removed (Figure 5-2). If you tighten the screw too much, adjusting the plate position will result more difficult.



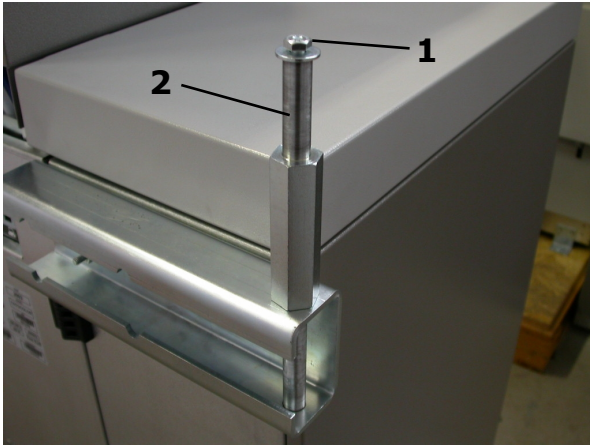

Figure 5-1



Figure 5-2

## 5.4 Canister filling and first machine startup

In the absence of colorant, the machine pumps are kept in good working order by the lubricant oil they contain.



*Follow the instructions in this chapter carefully to prevent the lubricant from entering the canisters and contaminating the colorants.*

The procedure for filling the canisters with colorant is described in chapter 7.5.



**To avoid emulsifying air into the product, never use automatic shakers to shake the colorant to be poured into the canisters. Shake manually.**



Prepare the service computer where the service and maintenance software "CorobSERVICE" is to be installed, which makes it possible to activate certain machine functions needed to correctly fill the canisters the first time without using the management program (chapter 9). To learn how to install, start and use the service and maintenance software "CorobSERVICE", refer to the corresponding user's manual.

The procedure for **the first canister filling** involves carrying out the purge and recirculation process: during **purging**, the colorant will fill the section of each circuit from the canister to the electrovalve, and the lubricant in each pump will flow out through the nozzle center without returning to the corresponding canister; during **recirculation**, the colorant will fill the return section to the canister in each circuit.

For more information on how to run the machine, refer to chapter 7.

### 5.4.1 Purge procedure

1. Fill the canisters (chapter 7.5).
2. Power up and start the machine as described in chapter 6.2.
3. Load an empty can.

#### **COROB TATOCOLOR with sliding cap**

- Position the manual shelf at such height that the can -- which will be lately placed -- will cause the sliding cap to open (chapter 7.2.1 or 7.3.1).
- Place a can onto the shelf so as to push the cap opening bar inward and thus cause it to open; make sure that the can is properly positioned under the nozzles.



**COROB TATOCOLOR with sliding Autocap**

- Position the manual shelf at the right height so as to bring the can, to be lately placed on the shelf surface, at the proper position in relation to the nozzles (chapter 7.2.1 or 7.3.1). The can should be positioned so as not to interfere with the opening movement of the sliding Autocap.
- Place a can onto the shelf making sure that it is properly positioned in relation to the nozzles.



The can must have an adequate capacity, at least enough to contain the amount of colorant dispensed during purging, taking into account the number of circuits and the duration of the purge process.

4. Purge the circuits using the "CorobSERVICE" program.
5. Stop the purge only when the colorant flowing out of the nozzle center is perfectly clean.

**5.4.2 Colorant recirculation procedure**

After purging the machine, all of the canisters and part of the dispensing circuits have been filled. It is therefore essential to recirculate the colorant to fill the return segment to the canister; this procedure will also remove the air emulsified with the colorant while filling the canisters.

1. Activate the recirculation process using the "CorobSERVICE" program.
2. Lift the canister section covers and check in each canister to make sure the colorant returns through the recirculation connector.
3. When the colorant begins to enter the canisters through the recirculation connectors, stop the process.
4. Close each canister with its corresponding lid, and close the section covers.
5. Shut off the machine and unplug the power supply cable from the socket outlet (chapter 6.4).

You may now disconnect the service computer (chapter 9).

**5.5 Connecting the computer and installing the software**

The structure of the dispenser has been designed to connect to a personal computer chosen by the customer, whose minimum requirements are listed in chapter 3.6.



We recommend that this connection be carried out by personnel skilled with computers.

To connect your computer to the machine, it is possible to use the **RS232 serial cable** provided in the packing.

The USB interface cable is no standard equipment, therefore you will have to purchase one suitable for the connection with the dispenser.

For any information on the computer, refer to the corresponding user's manual.

The area dedicated to housing the machine management computer, monitor and keyboard is the upper surface of the dispensing section. The computer can be placed on the adjustable support plate available as an optional accessory.

The machine has auxiliary sockets on the rear door with the exclusive purpose to power the computer and all peripheral equipment such as label printer or calibration scale (chapter 6.2).

The auxiliary sockets are powered when the machine main switch is switched on (chapter 6.2).

To power up the computer use the power cords provided in the packing (chapter 4.4).

1. Position the computer.

## 5-4 5-INSTALLATION

2. If the computer is complete with monitor and keyboard, connect as needed. The keyboard cable can be hidden inside the dispensing head (chapter 5.5.1).
3. Connect the computer and monitor power supply cords to the auxiliary sockets on the rear door (Figure 5-3). **Do not use power cords that are not in good condition or are unsuitable.**

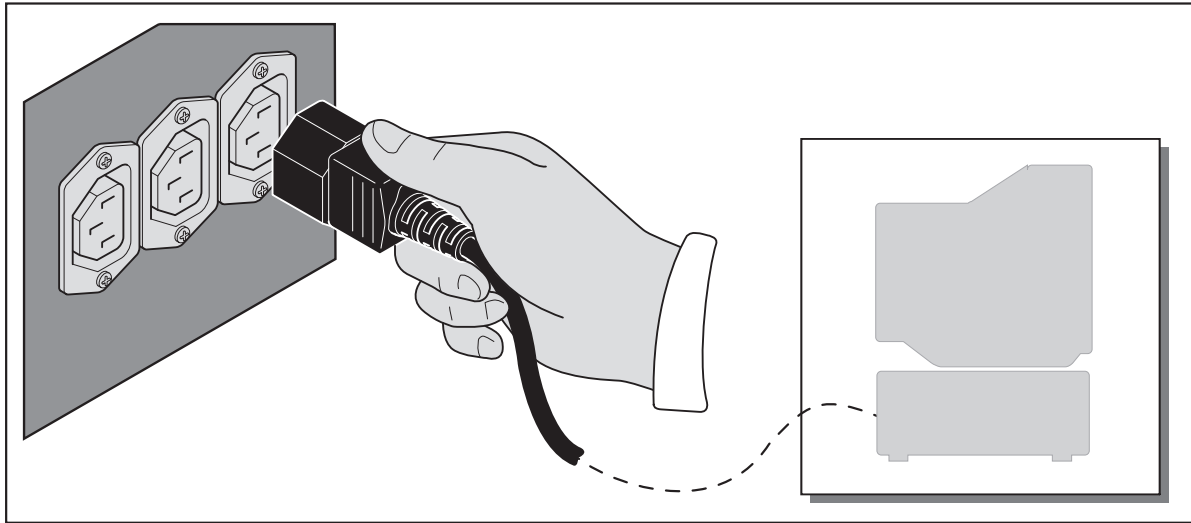



Figure 5-3

4. Connect the computer to the machine as follows:

### RS232 serial connection

- Connect the 9-pin female connector of the communication cable to the serial port of the computer (preferably serial port COM1); if the serial port connector of your computer has 25 pins, use a 9/25-pin adapter.
- Insert the communication cable connector (RJ11 male) into the connector (RJ11 female) on the rear door, marked with the symbol  (Figure 5-4).

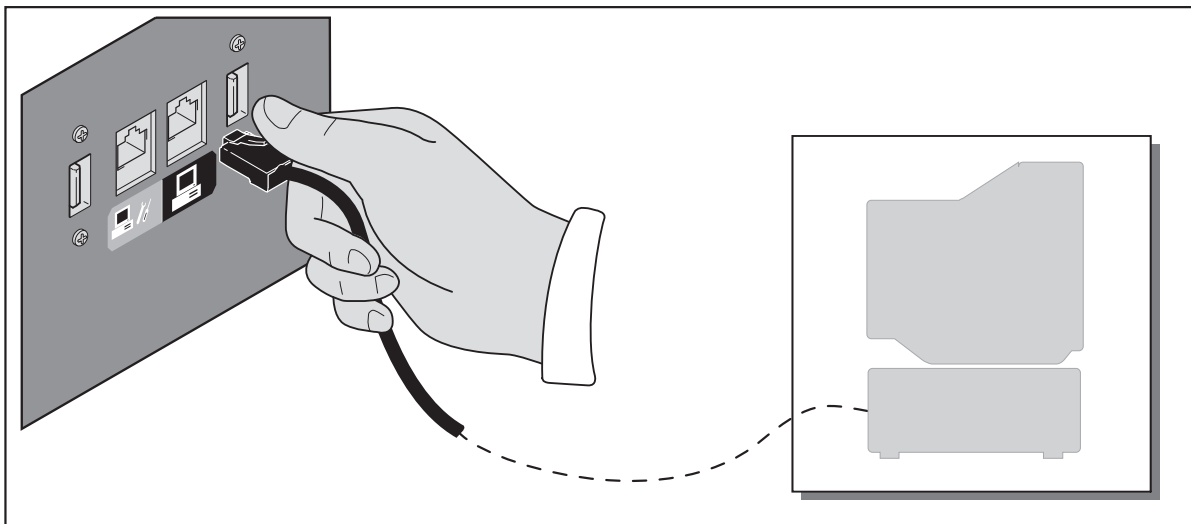



Figure 5-4

### USB connection

- Connect the USB interface cable to the dispenser USB port, marked with the symbol  (Figure 5-5).
- Connect the other end to one of the USB ports of the computer.



*Do not use an USB interface cable longer than 2 meters. USB not supported in Microsoft Windows 95 or Microsoft Windows NT 4.0.*

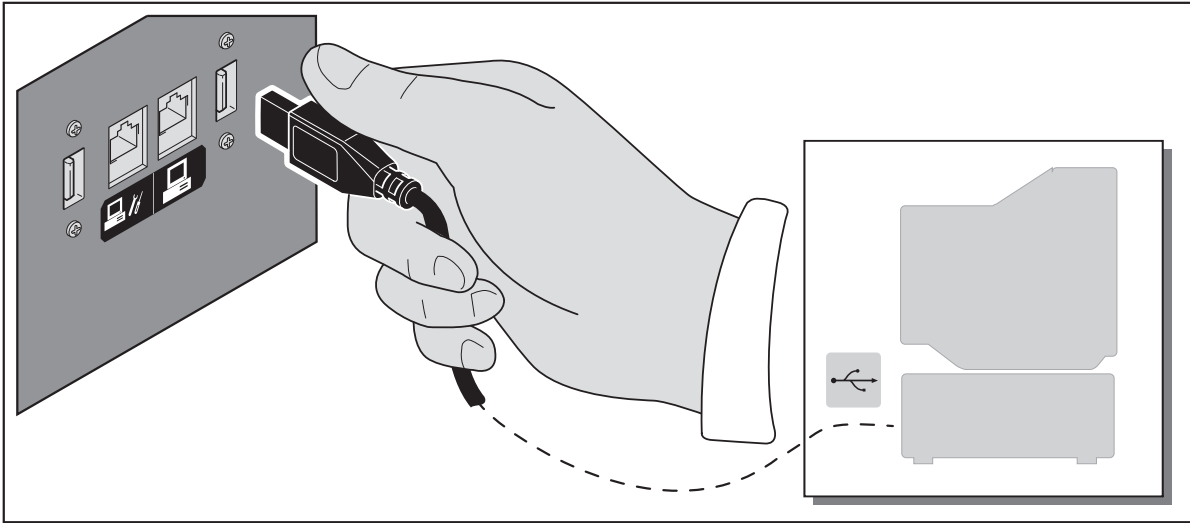

Figure 5-5

5. Load the management application program onto your computer.
  - Press the computer and monitor start switches to turn them in ON position (I).
  - Power up and start the machine as described in chapter 6.2.
  - When the computer is booted up, install the application program (see the program user's manual).

### 5.5.1 Installing the keyboard (only model TB, with sheet metal panels)

Insert the cable inside the dispensing head until it comes out from the rear and connect it to the computer as follows:

1. Loosen the screws to remove the keyboard support panel.
2. Completely insert the keyboard cable into the hole provided.
3. Reassemble the keyboard support panel.
4. Loosen the screws to remove the rear panel of the dispensing head and pull the keyboard cable.
5. Insert the cable in the slot provided in the rear panel and reassemble the panel.

### 5.5.2 Machine configuration through the management program



Use the **CorobTECH** configuration and calibration program at this point to configure the machine, **taking special care in associating colorants-canisters and in recording the amount of colorant added to the canisters** during installation (chapter 5.4) (see the program user's manual).

## 5.6 Moistening the cap sponge

Installation now requires that you insert the sponge in the humidifier cap and moisten it for the first time. The sponge is available among the material supplied.

The sponge serves to keep the dispensing nozzle center at a moisture level to prevent the colorant from drying out.

The procedure for moistening the sponge is described in the chapter on ordinary maintenance of the humidifier cap, specifically in chapter 8.4.

## **5.7 Calibration**

---

Since the characteristics of the colorant in relation to the circuit containing it greatly affect the machine's precision, it is essential to **CALIBRATE** all of the dispensing circuits. The CorobTECH program allows you to automatically calibrate the machine starting from theoretical calibration parameters.

We recommend that you use **CorobTECH, last released version**.

 After filling the canisters, we recommend leaving the colorant to degas from air for 8-12 hours before calibrating; during this time it is advisable to increase the automatic stirring frequency so that the colorants are in ideal condition during calibration.

To calibrate the machine, you must use a precision scale since the actual calibration parameters are calculated based on the weight of the amounts dispensed during calibration.

You may use an electronic scale that can interface with the computer, among those managed by the calibration program. See the scale manual for instructions on interfacing the scale with the machine management computer. In any case, it is advisable to use the COM2 serial port on the computer.

 The actual specific weights of the colorants present in the machine must be entered into the calibration program.

The instructions for automatically calibrating the dispensing circuits of the machine are described in detail in the program user's manual.

## 6 START-UP

### 6.1 General warnings

The machine is manufactured according to various electrical power standards (see technical specifications). The type of power supply is indicated on the identification plate.

*THIS EQUIPMENT MUST BE GROUNDED.*

*Check the grounding of the power supply system before connecting the machine.*



*The computer and any other devices connected to the machine via a serial line or connected to the computer itself must be powered via the auxiliary sockets.*

*Do not use extension cords to power the machine. Do not use multisoquets to connect other equipment to the same socket that powers the machine.*



*Do not attempt to power the machine from a source having specifications other than those listed on the identification plate.*

*The machine is isolated from the power supply line when the power cable is disconnected; it must therefore be installed near an easily accessible mains socket outlet.*

*Do not use multisoquets to connect other equipment to the machine auxiliary sockets.*

The machine is equipped with a power supply cable having the following specifications: length 2,5 m, cross-section 3 x 1 mm<sup>2</sup>.

The power supply cable conductors are color-coded as follows:

GREEN/YELLOW = <b>GROUND</b>	BLUE = <b>NEUTRAL</b>	BROWN = <b>LINE</b>
------------------------------	-----------------------	---------------------

### 6.2 Electrical connection and start-up

The following are present on the **REAR DOOR** of the machine dispensing section (Figure 6-1):

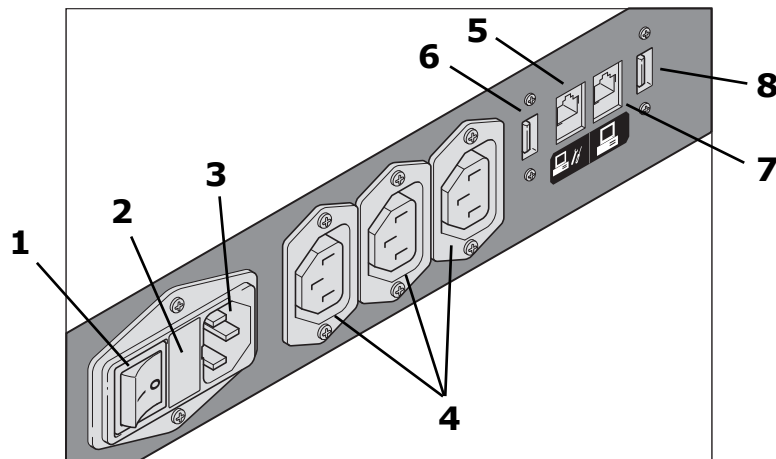



Figure 6-1

<b>Machine main switch (1)</b>	In ON position (I), the machine is powered. In OFF position (O), the power is cut off to the machine.
<b>Fuse compartment (2)</b>	The two fuses protect the line and neutral in the electrical socket; the value is shown in the technical specifications table.

<b>Main plug (3)</b>		Main power supply to the machine.
<b>Auxiliary sockets (4)</b>		Power supply to the computer and other equipment (calibration scale or label printer).
	<b>RS232 serial port for service computer (5)</b>	RJ11 female connector for the RS232 serial interface connection to the service computer.
	<b>USB port for service computer (6)</b>	Connector for the USB interface connection to the service computer.
	<b>RS232 serial port for management computer (7)</b>	RJ11 female connector for the RS232 serial interface connection to the machine management computer.
	<b>USB port for management computer (8)</b>	Connector for the USB interface connection to the machine management computer.

The following device is present on the dispensing section, in a functional position for the operator station (Figure 6-2):

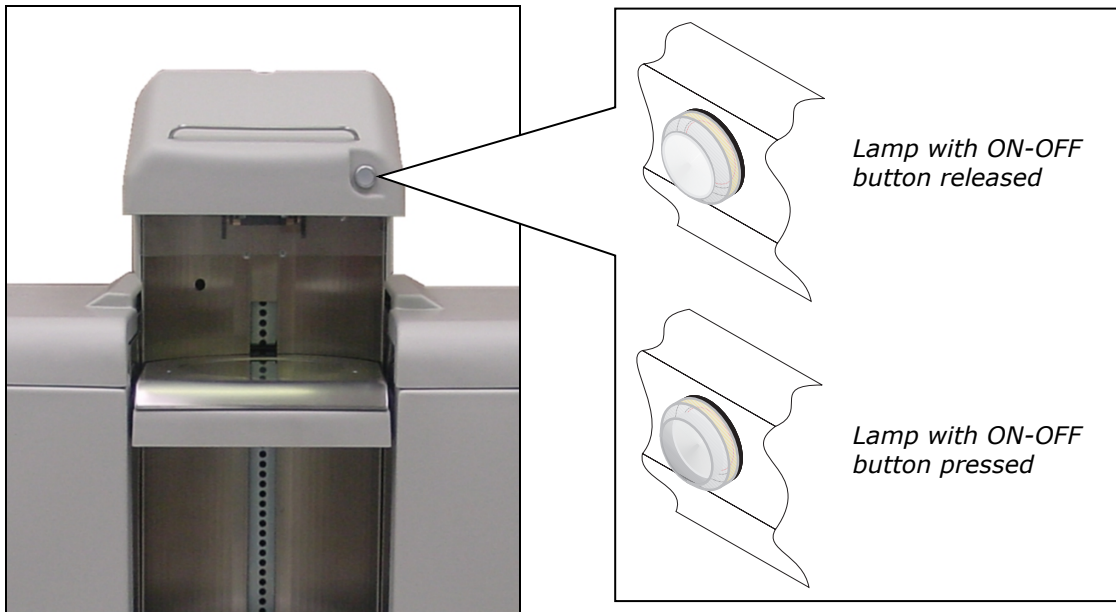

Figure 6-2

### **ON lamp, with built-in ON-OFF button**

White lamp, with built-in button. When this lamp is lit, it indicates that the machine is powered and the main switch is in the ON position (I). When the ON-OFF button is pressed, power is cut off to the machine control circuits and the ON lamp turns off, but the auxiliary sockets remain powered.

To power up and start the machine, proceed as follows:

1. Visually make sure that the main switch is in the OFF position (O).
2. Visually make sure that the ON-OFF button is not pressed.
3. Insert the power supply cable socket into the main machine plug (Figure 6-3), and the other end to the mains socket outlet.
4. Set the main switch to the ON position (I) (Figure 6-4). At this point, the ON lamp will light to indicate that the machine is on.
5. Turn on the computer and monitor.

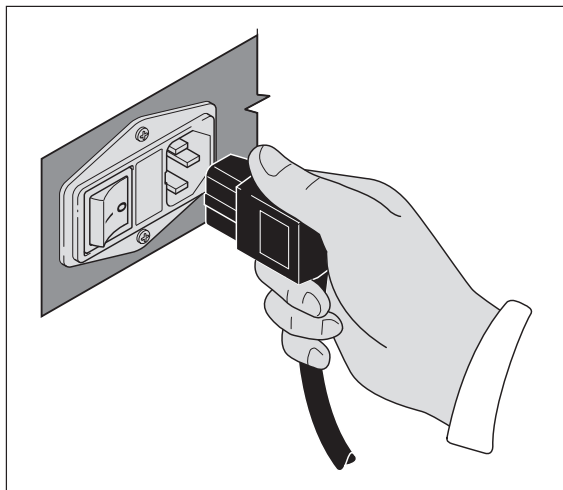

Figure 6-3

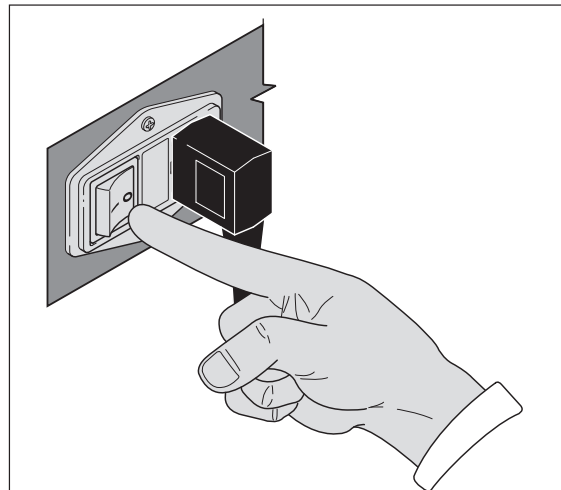



Figure 6-4

Once the machine has been turned on, it prepares for use by automatically carrying out a system check.

 If the ON lamp does not light, make sure that the ON-OFF button is released.

 If the computer and monitor do not come on, make sure the power cables have been properly inserted in the auxiliary sockets, and that the corresponding switches have been turned on as described in the installation procedure (chapter 5.5).



When the program is launched it offers the operator a series of procedure requests, including initialization (see the user's manual for the application software).

### 6.3 Initialization

**INITIALIZATION** is a preparatory phase that must be carried out when the machine is turned on, and when the configuration parameters are set again.

 If the computer only is turned off and back on again, initialization is not strictly necessary, even if required by the program; it is solely at the discretion of the operator.

The initialization procedure is divided into two stages.

The first stage is the **Pump release**. During this process, the pumps are activated at low speed for an interval defined via the application program, to start the colorants moving along the dispensing circuits.

It is especially important in those cases when the machine is temporarily shut down, or in colder seasons when the viscosity of the colorants increases, because it allows the pumps to be started less traumatically and thus increases their life-span.

The second stage is **Recirculation**. During this process, colorants are recirculated through the dispensing circuits at high speed for the time interval defined via the application program.

During initialization, the application program sends the machine the times and parameters that control the timed stirring and colorant recirculation processes and that govern operation of the accessories and optional devices with which the machine is equipped.

The start-up phase of the application program also involves carrying out dispensing test or nozzle purging, at the operator's discretion (based on the configuration of the application software). Once the start-up phase is complete, the application program is set to a logical, pre-defined state awaiting commands from the keyboard.

The timed process of **Stirring** begins after a few seconds of machine inactivity (chapter 7.4).

## 6.4 Shut-down

---



**WE RECOMMEND THAT YOU NEVER SHUT DOWN THE MACHINE**, even when closed for business, because the automatic, timed recirculation and stirring functions help keep the colorant preserved and homogeneous.

*Should it be essential to shut down the machine, avoid keeping it off for extended periods of time. When the machine is not being used, shut off only the computer.*

To shut off the machine proceed as follows:

1. After carrying out the computer shut-down procedure, shut off the machine by setting the main switch to the OFF position (O).
2. Unplug the power supply cable from the mains socket outlet.

For occasional and temporary needs to shut off the machine, press the ON-OFF button.



Pressing the ON-OFF button does not cause all the electrical circuits to be isolated from the mains voltage, but only isolates the electronic control devices (power supply unit, inverter, etc.). The auxiliary sockets still remain powered.



## 7 USING THE DISPENSER

---

### 7.1 General warnings

---

*The machine must be used by a single operator.*

*It is strictly forbidden to bypass or disable the safety devices and protections.*



*The rear door and panels must be kept closed at all times.*

*The substances that may be used on the machine--such as colorants, paints, solvents, lubricants and cleansers--may be hazardous to your health; handle, store and dispose of these substances in keeping with current regulations and the instructions provided with the product.*

The operator is guided in running the machine by the COROB management application program, which displays the instructions to be carried out and the actions performed by the machine.

After selecting the appropriate options from the application program (selection of the product, formula and cansize) proceed as described in the following chapters.

#### 7.1.1 Warnings on the use of colorants

---



**Before using any colorant, carefully read the SAFETY DATA SHEET that the dealer or manufacturer of the product is required to provide, and observe all of the safety instructions provided.**

Below are some of the most common warnings and safety precautions provided by colorant manufacturers.

*Harmful if swallowed.*

*Avoid eye and skin contact. In case of eye and skin contact, rinse with plenty of water.*

*Keep out of the reach of children.*

*When compulsory, use personal protection equipment for eyes and hands.*

*In case of accidental product leaks or spills, thoroughly ventilate the area and clean immediately with water.*

*Do not dispose of colorant in the sewage system. Follow local regulations when disposing of waste.*

### 7.2 Running COROB TATOCOLOR TB

---



*After you have loaded the can and confirmed dispensing, keep hands away from the dispensing area, until when the machine has finished dispensing.*

#### 7.2.1 Positioning/loading cans

---

The machine is accessorized with a **manual shelf** allowing the cans or bins to be aligned with the dispensing nozzles.

The manual shelf is fixed to the machine and can be raised or lowered so as to place cans of different sizes under the dispensing nozzles.

### **COROB TATOCOLOR with sliding cap**

According to the position of the humidifier cap, the management computer checks for the can presence. Only after the can is placed on the shelf, thus causing the cap to open, it will be possible to start dispensing.

1. Release the shelf by pulling the locking handle hidden beneath, raise or lower the shelf, adjusting its height based on the size of the can to be used. Then release the handle to lock the shelf in the desired position.



*RISK OF CRUSHING.*

---



*The shelf position must be such that it allows the can -- to be lately placed -- to push the cap opening bar.*

2. Place the can on the shelf to push the cap opening bar inward and thus cause it to open; make sure the can is properly positioned under the dispensing nozzles.
3. If the machine is fitted with the B.H.L., after having correctly positioned the can, the laser beam will switch on automatically and the point it indicates on the can is the position that the can hole must be in to perfectly match the nozzle center.
4. Confirm dispensing (next chapter).

### **COROB TATOCOLOR with sliding Autocap**

The management computer checks for the can presence by means of a photocell located underneath the nozzle center. Only when the can resting on the shelf is detected by the photocell it will be possible to start dispensing.

1. Release the shelf by pulling the locking handle hidden beneath, raise or lower the shelf, adjusting its height based on the size of the can to be used. Then release the handle to lock the shelf in the desired position.



*RISK OF CRUSHING.*

---



*The shelf position must be such that it does not cause the can to interfere with the opening movement of the automatic sliding cap, but must anyway ensure proper engagement of the photocell.*

2. Place the can on the shelf; the sliding Autocap opens automatically when the can is detected by the photocell. The sliding Autocap closes automatically when the shelf is lowered and the photocell disengaged or when the can is removed from the shelf.
3. If the machine is fitted with the B.H.L., after having correctly positioned the can, the laser beam will switch on automatically and the point it indicates on the can is the position that the can hole must be in to perfectly match the nozzle center.
4. Confirm dispensing (next chapter).

## **7.2.2 Dispensing**

---



*After you have loaded the can and confirmed dispensing, keep hands away from the dispensing area, until when the machine has finished dispensing.*

---

Once the dispensing command has been received, the machine will begin to dispense the colorants included in the formula in the set amounts. The dispensing time is the time required by the colorant of which the greatest amount is used in the formula.

After dispensing, you may remove the can from the shelf and proceed with the next dispensing process.

## 7.3 Running COROB TATOCOLOR TA



*The punch tool is a very sharp instrument. The can-holding plate is installed for safety purposes as well. Never push the plate upward.*

### 7.3.1 Positioning/loading cans

The machine is accessorized with a **manual shelf** allowing the cans or bins to be aligned with the dispensing nozzles.

The manual shelf is fixed to the machine and can be raised or lowered so as to place cans of different sizes under the dispensing nozzles.

The management computer checks for the can presence by means of a photocell located underneath the nozzle center. Only when the can resting on the shelf is detected by the photocell it will be possible to start dispensing.

1. Release the shelf by pulling the locking handle hidden beneath, raise or lower the shelf, adjusting its height based on the size of the can to be used. Then release the handle to lock the shelf in the desired position.



**RISK OF CRUSHING**



*The shelf position must be such that it does not cause the can to interfere with the opening movement of the automatic sliding cap, but must anyway ensure proper engagement of the photocell.*

2. Place the can on the shelf; the sliding Autocap opens automatically when the can is detected by the photocell. The sliding Autocap closes automatically when the shelf is lowered and the photocell disengaged or when the can is removed from the shelf.
3. After placing the can properly, proceed with manual punching (next chapter).

### 7.3.2 Punching the can lid



Remember to carry out manual punching **BEFORE** ordering the application program to dispense the formula.

1. If illuminated, press and hold down the green enabling button  (1) and lower the punch side lever (2) to make a hole in the can lid (Figure 7-4). If the green button is not illuminated, it means that the can has not been correctly positioned (previous chapter).
2. Release the button and return the lever to its original position.

After punching, dispense the formula by entering the command in the application program (next chapter).

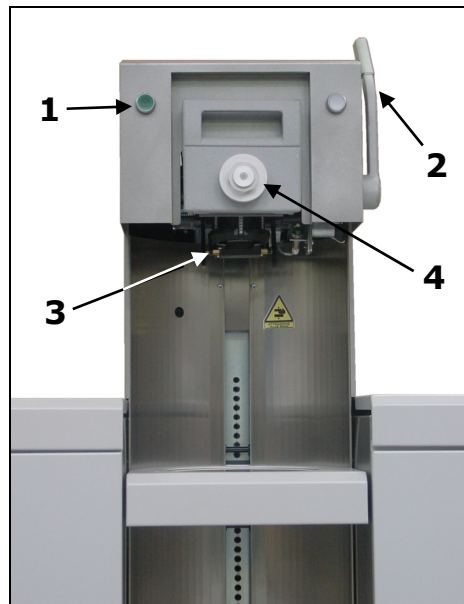

Figure 7-1

### 7.3.3 Dispensing



*After you have loaded the can and confirmed dispensing, keep hands away from the dispensing area, until when the machine has finished dispensing.*

Once the dispensing command has been received, the machine will begin to dispense the colorants included in the formula in the set amounts. The dispensing time is the time required by the colorant of which the greatest amount is used in the formula.

After dispensing, you may proceed with inserting the plastic plug on the can (next chapter).

### 7.3.4 Inserting the plastic plug on the can lid

1. Insert the plastic plug into the slot provided on the plugger device (1) (Figure 7-4).
2. Grasp the upper plugger grip (2) and lower it to turn the device downward, into working position (3) (Figure 7-4 and Figure 7-3).
3. If illuminated, press and hold down the green enabling button  (4) and lower the punch side lever (5) to insert the plug (Figure 7-3). If the green button is not illuminated, it means that the can has not been correctly positioned (chapter 7.3.1).
4. Release the button and return the lever to its original position.
5. Grasp the plugger grip again and raise it, to turn the plugger upward into its resting position.

At this point, you may remove the can from the shelf and proceed with the next dispensing process.

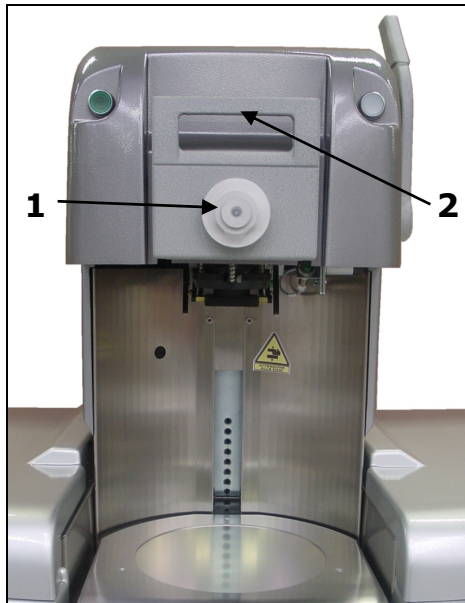

Figure 7-2

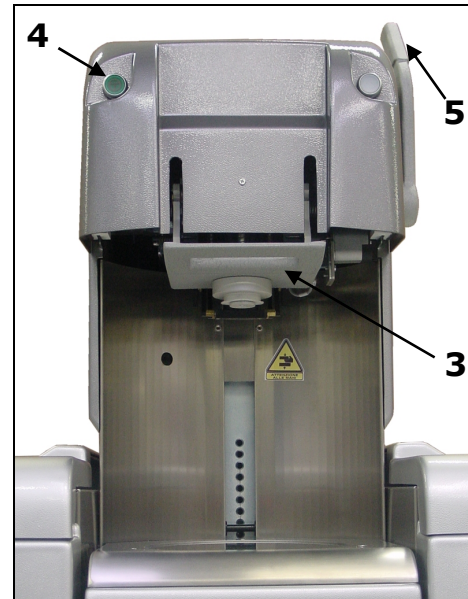

Figure 7-3

## 7.4 Automatic timed processes

**Recirculation and stirring** are two timed processes, activated automatically to properly store the product in the canisters and keep it in ideal, homogeneous conditions for dispensing.



The times regulating these processes may be set via the configuration program (see the CorobTECH program user's manual) depending on the physical nature of the colorants used on the machine.

Recirculation and stirring may also be activated directly by the operator whenever necessary.

The **Recirculation** process consists of activating the pumps at high speed to draw the colorant out and return it to the canisters; the colorant leaves the bottom of the canister and returns in the canister through the recirculation connector, without being dispensed through the nozzle center.

This process circulates the colorant through the dispensing circuits, avoiding pigment sedimentation in the various parts of the circuit.

The **Stirring** process consists of activating the stirrers located inside the canisters, one after another, beginning with the one inside the first canister; the stirring process ends when the last canister has been stirred. The movement of the stirrers keeps the colorant in the canisters homogeneous.

Stirring also serves to prevent the precipitation of pigments, flocculation and sedimentation of the colorants in the canisters.

The rotation speed of the stirrers prevents the formation of air emulsions and other negative effects that could interfere with the machine's performance.



*Keep the canisters closed with their corresponding lids, and do not insert hands in the canister even when no colorant is present.*



The stirring and recirculation times set via the application program are sent to the machine during initialization; the timed processes are active even if the machine is turned on without the computer.

 Whilst a timed process is in progress, the machine can still be used (dispensing or other process from the management application program). The process in progress will be suspended and restarted after a few seconds that the machine is inactive.

## 7.5 Refilling the canisters

 **Before using any colorant, carefully read the SAFETY DATA SHEET that the dealer or manufacturer of the product is required to provide, and observe all of the safety instructions provided. When compulsory, use personal protection equipment for eyes and hands.**



COROB management programs control the level of colorant in the machine canisters to ensure the hue of the paint being produced. By knowing the initial level for each colorant, the program can decrease the level based on the amount dispensed.

The update of colorant level from the program is consistent with the actual level of colorant in the canisters only if the quantities added are correctly recorded in the program itself.

An incorrect recording of colorant quantities may empty the canisters after dispensing, leading to mistints and lack of machine's performance, due to circuit emptying.



*It is essential to avoid letting the level of colorant fall too low or, worse yet, allowing the machine canisters to empty completely.*



Using the COROB management programs, a reserve level is set for each canister in proportion to its capacity, to prevent it from emptying; when the colorant in a canister reaches the reserve level, the program prevents all formulas involving the colorant in reserve from being dispensed.



*Scrupulously follow the safety precautions and the instructions for use given on the colorant package; when compulsory, use personal protection equipment for eyes and hands.*



*When using **colorants containing volatile solvents** the canister top up must be carried out sequentially, opening one canister at the time.*

*If during this operation, some colorant should spill out of the canister, immediately shut down (electrical stop) the machine before cleaning.*



*If "SOLVENT FREE" colorants are used, or those that dry out quickly, we recommend that you keep the canisters full at all times by topping up frequently. For more information on this matter, refer to chapter 10.*

To add colorant to a canister, proceed as follows:

1. **Shut off the machine temporarily, by pressing the ON-OFF button** to prevent the recirculation and stirring processes from being automatically activated while you are topping up.
2. Lift the canister section cover where the canister to be filled is located.
3. Remove the lid of the canister to be filled.
4. Add the desired amount of colorant to the canister carefully to avoid spattering or creating air emulsions in the colorant.



Never exceed the maximum colorant level in the canister, approximately 1.5 cm under the recirculation connector (Figure 7-5).

Never pour colorant directly onto the stirrer shaft (Figure 7-4/Figure 7-5).



Figure 7-4

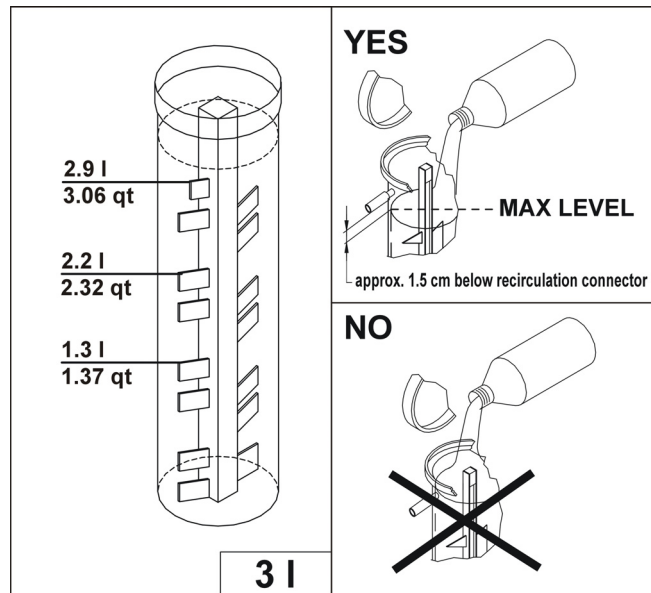

Figure 7-5

5. Close the canister with its corresponding lid.
6. Repeat the above steps to fill other canisters.
7. Close the canister section covers and restart the machine by releasing the ON-OFF button.



Each time colorant is added to the canisters, it is essential to update the amount of colorant associated with the topped up canisters, entering the new colorant level in the program (see the application program user's manual).



Update the levels **IMMEDIATELY AFTER** topping up the colorant in the machine canisters, so that you do not forget to do so later.



Changing the levels so that they do not match the actual amount of colorant added to the canisters may compromise the accuracy of the hue produced or, worse yet, cause malfunctions in the machine due to emptying the canisters and circuits.

After topping up, it is advisable to carry out the recirculation and stirring processes using the functions provided in the management application program, to eliminate any air that may be emulsified and incorporated into the colorant.

BLANK PAGE



## 8 ORDINARY MAINTENANCE (by the user)

### 8.1 General warnings

Performing ordinary maintenance regularly ensures safe, reliable machine operation.



*Before carrying out any ordinary maintenance operations, you must turn off the machine and unplug the power supply cable from the mains socket outlet.*



The frequencies indicated are approximate, since they depend on the type of colorants and environment conditions.



*Make sure to use products compatible with the type of colorants in the machine when: cleaning the nozzle center - moistening the humidifier cap sponge - cleaning the filters.*

Type of colorant:	Use:
Solvent-based colorants	slow-evaporating solvent, compatible with the colorants used
Water-based colorants	water
Mixed systems	the choice depends on the type of vehicles used to produce the colorants; this choice may be made directly by the customer's product development laboratory or, alternatively, by the COROB S.p.A. laboratory after examining the formulas and a few samples of the products used.

During the maintenance operations described below, follow the safety instructions given; refer to chapter 2.6 for further clarification of the definitions.

Machine status:	shut off and unplugged from the power source
Number of operators:	1
Qualification:	operator

#### 8.1.1 Warnings on the use of colorants



***During machine maintenance operations there is a high risk of contact with the coloring products; carefully read the SAFETY DATA SHEET that the dealer or manufacturer of the product is required to provide, and observe all of the safety instructions provided.***

Below are some of the most common warnings and safety precautions provided by colorant manufacturers.

*Harmful if swallowed.*

*Avoid eye and skin contact. In case of eye and skin contact, rinse with plenty of water.*

*Keep out of the reach of children.*

*When compulsory, use personal protection equipment for eyes and hands.*

*In case of accidental product leaks or spills, thoroughly ventilate the area and clean immediately with water.*

*Do not dispose of colorant in the sewage system. Follow local regulations when disposing of waste.*

## 8.2 Maintenance table

\* The value is purely indicative.

EVERY beginning of shift *	EVERY 20 hours *	EVERY 50 hours *	EVERY 1000 hours *	OPERATIONS
X				Clean the dispenser externally (chapter 8.3.1)
X				Accurately clean the dispensing nozzles (chapter 8.3.2)
X				Clean the lenses and the external photocells (chapter 8.3.1)
	X			Moisten the sponge of the humidifier cap (chapter 8.4)
		X		Check the condition of the punch tool (chapter 8.5)
			X	<b>Pump filters</b> - Check and eventually clean the pump filters <b>after the machine has been running approx. for 6 months</b> ; perform periodic maintenance thereafter, based on the conditions found during the visual check (chapter 8.6)

## 8.3 Cleaning

### 8.3.1 External cleaning (dispenser)

The machine may get dirty accidentally (paint spills) or due to dust build-up over time. In the first instance, the machine must be cleaned immediately; periodic cleaning will suffice for the latter.

**Every beginning of shift (daily)** we recommend a general cleaning of coverings, panels and control devices of the machine, to remove dirt, dust and any colorant stains, using a soft and dry cloth, or slightly moistened with a mild cleansing solution.



*Never use a solvent-based cleaning product or abrasive powder, since they might ruin surfaces.*

Clean all of the photocell lenses (if any) using a cloth moistened with a mild cleansing solution; do not use alcohol or abrasive products.

See the manufacturer manual for instructions on cleaning the computer.

### 8.3.2 Cleaning the nozzle center

For precise dispensing, it is essential to keep the dispensing nozzles in the best possible condition.

**Every beginning of shift (daily)** check the condition of the nozzle center.

If necessary, clean the nozzles carefully with a damp cloth.

The type of product to use depends on the type of colorants used on the machine; follow the table given in chapter 8.1 for the type of solution to be used.

Remove any dried colorant residue with a sharp tool.



*Perform this operation delicately to avoid damaging the ends of the dispensing circuits that make up the nozzle center.*

Follow the instructions in the table below to correctly clean based on the accessories installed on the machine.

Accessories	Cleaning the nozzles
with sliding cap (Figure 8-1)	<ul style="list-style-type: none"> <li>- <b>Shut off the machine and unplug the power supply cable</b> (chapter 6.4).</li> <li>- Open the sliding cap by pushing the opening bar inward with your hand.</li> <li>- Perform maintenance on the nozzles.</li> <li>- Bring back the sliding cap in its closed position.</li> <li>- Connect the machine to the power mains and switch it on (chapter 6.2).</li> </ul>
with sliding autocap	<ul style="list-style-type: none"> <li>- Open the autocap by loading a can on the machine.</li> <li>- <b>Shut off the machine and unplug the power supply cable</b> (chapter 6.4).</li> <li>- Perform maintenance on the nozzles.</li> <li>- Connect the machine to the power mains and switch it on (chapter 6.2); the autocap closes automatically when the can is removed from the shelf.</li> </ul> <hr style="border: 1px solid red;"/> <div style="display: flex; align-items: center;"> <p><b>RISK OF CRUSHING</b></p> </div> <hr style="border: 1px solid red;"/>

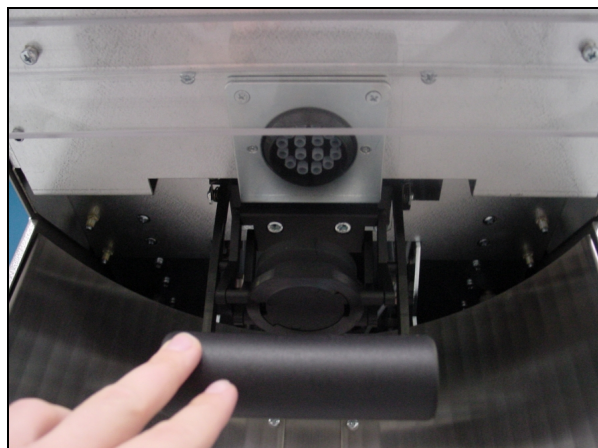

Figure 8-1

## 8.4 Moistening the humidifier cap sponge

In addition to keeping the nozzle center clean at all times, in order to obtain precise dispensing from the machine it is essential that the nozzle center be kept at a moisture level to prevent the colorant from drying out.

For this purpose, the humidifier cap installed on the machine contains a sponge or piece of felt that must be kept moist at all times.

**Every 20 hours (approximately every two days)** moisten the sponge.

8-4 **8-ORDINARY MAINTENANCE**

The type of cleaning product to use depends on the type of colorants used on the machine; follow the table given in chapter 8.1 for the type of solution to be used.

 Should mould form in the autocap and in the sponges it is advisable to use the following fluids:

- Propylene glycol solution, 50% by volume, in water;
- AgCl solution in water;
- Bleach.

Visually check the status of the sponge and moisten as needed. The level of the humidifying liquid must not exceed the height of the sponge.

If it is very dirty, remove the sponge from the cap and wash it thoroughly.

Replace it if it is severely damaged.

 Do not use sponges different from the ones supplied.

Follow the instructions in the table below to correctly intervene based on the accessories installed on the machine.

Model/Accessories	Cleaning the nozzles
TATOCOLOR TB with sliding cap	<ul style="list-style-type: none"> <li>- <b>Shut off the machine and unplug the power supply cable</b> (chapter 6.4).</li> <li>- Open the sliding cap by pushing the opening bar inward with your hand.</li> <li>- Unscrew the sponge holding lid and remove it.</li> <li>- Release the lever of the sliding cap to bring it back in its closed position.</li> <li>- Wash the holding lid and perform maintenance on the sponge.</li> <li>- Push the opening bar to cause the cap to open.</li> <li>- Screw back the sponge holding lid.</li> <li>- Release the lever of the sliding cap to bring it back in its closed position.</li> <li>- Connect the machine to the power mains and switch it on (chapter 6.2).</li> </ul>
TATOCOLOR TB with sliding autocap	<ul style="list-style-type: none"> <li>- Open the autocap by loading a can on the machine.</li> <li>- <b>Shut off the machine and unplug the power supply cable</b> (chapter 6.4).</li> <li>- Unscrew the sponge holding lid and remove it.</li> <li>- Wash the holding lid and perform maintenance on the sponge.</li> </ul>
TATOCOLOR TA	<ul style="list-style-type: none"> <li>- Screw back the sponge holding lid.</li> <li>- Connect the machine to the power mains and switch it on (chapter 6.2); the autocap closes automatically when the can is removed from the shelf.</li> </ul>
 <b>RISK OF CRUSHING</b>	

## 8.5 Checking and replacing the punch tool (model TA)



To work on the punch tool you must remove it; this is possible only by using the special punch tool screwing/unscrewing device (next chapter).

**Every 50 hours (weekly)** check the status of the punch tool.

If necessary, clean the internal and external surfaces of the punch tool to remove encrusted matter, using a cleaning product compatible with the type of bases used in your system.

To prevent base deposits from adhering tightly to the punch tool, we recommend lubricating its walls with a common, non-contaminant lubricant (we recommend ENOTAP or a similar type).



If the can punching is inadequate because the cutting edge of the punch tool is excessively worn, replace the worn punch tool.

### 8.5.1 Using the punch tool screwing/unscrewing device

(Figure 8-2)

The punch tool screwing/unscrewing device consists of two parts:

**(1) A protected grip with threaded end to remove and reassemble the punch tool.**

**(2) A manual plunger that can be inserted on the grip to manually apply plastic plugs to the cans.**



The punch is threaded to the left (the reverse of normal screws).

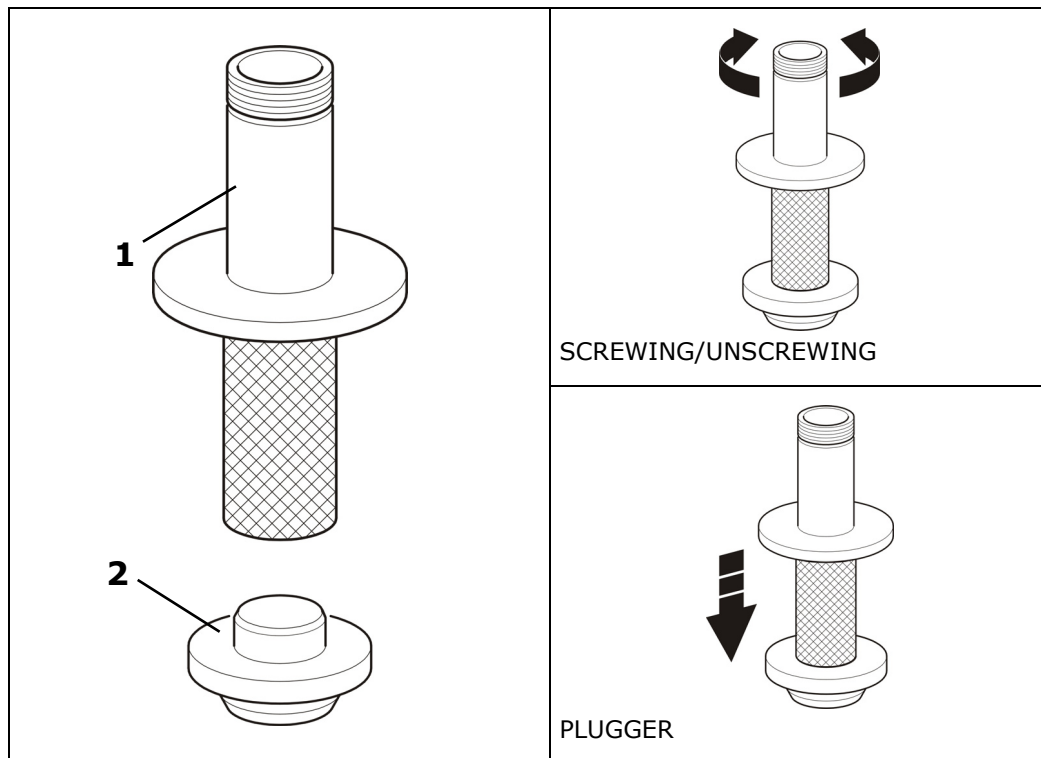

Figure 8-2

Carefully follow the procedure described below to remove the punch tool:



**At least 2 people must work together** to remove the punch tool.

**RISK OF CUTS.**

## 8-6 8-ORDINARY MAINTENANCE

1. With the machine on, press and hold down the green enabling button  to open the sliding autocap.
2. Lower the punch side lever and keep it in this position.
- 3. Shut off the machine by pressing the ON-OFF button (chapter 6.2).**
4. While the first person keeps the punch lever down, the second operator can disassemble the punch tool as follows:
  - Insert the threaded end of the device into the punch tool cavity.
  - Turn the device clockwise all the way down; forcing it further, still clockwise, the punch tool is released and then unscrewed. The punch tool remains firmly inserted on the device.
  - Insert a screwdriver or similar into the hole on the punch tool to release the device.
  - Turn the device counter-clockwise to separate it from the punch tool.



*Always wear cut-proof gloves when handling the loose punch tool.*

5. Follow the procedure described in point 4 in reverse order to reassemble the punch tool on the machine.
6. Return the lever to its original position.
7. Switch the machine back on, by releasing the ON-OFF button. The sliding autocap closes automatically.



*Handle the punch tool with care to avoid damaging its cutting edge.*

## 8.6 Filter maintenance

Number of operators: 1

Qualification: maintenance technician



*The flow rate and precision of the machine could be jeopardized by excess residue in the colorant, trapped in the pump filters (1) (Figure 8-3).*

*Filter clogging could reduce the machine flow rate, leading to imprecise dispensing (Figure 8-3).*

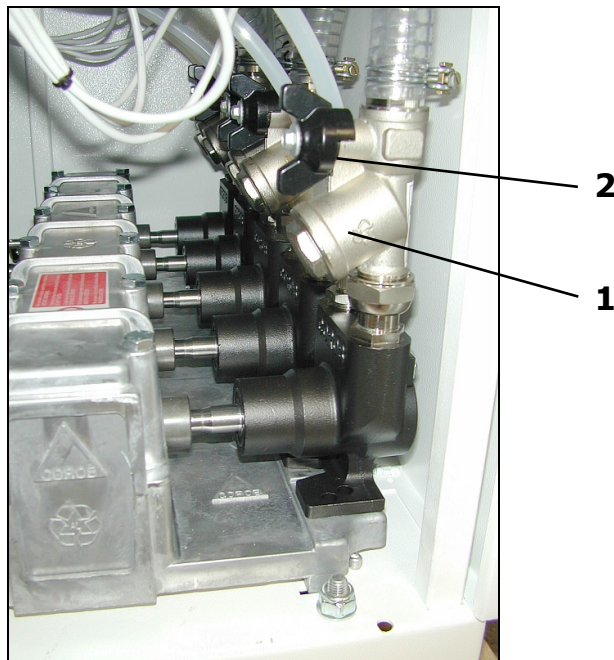

Figure 8-3

The frequency with which the filters must be cleaned depends on the colorants used on the machine; the following factors affect the frequency: type of colorant (organic/inorganic), pigment dispersion, sedimentation, viscosity, climatic conditions in the place where the machine is installed, etc.



Only qualified personnel may clean the filters.



Check and eventually clean the pump filters **after the machine has been running for 6 months**; perform periodic maintenance thereafter, increasing or decreasing the intervals based on the conditions found during the first check.

Clean the filters as follows:

1. **Shut off the machine and unplug the power supply cable** (chapter 6.4).
2. Use the screwdriver provided to open the panels of the canister sections.
3. Close all of the taps (2), located above the pumps, to stop the flow of colorant (Figure 8-3).
4. Connect the machine to the power mains and switch it on (chapter 6.2).



*Machine ON with safety protections removed - RISK OF CRUSHING - Do not reach into the dangerous area.*

The machine will initialize when it is turned on (chapter 6.3).



*Initialization with the protection panels removed from the machine is hazardous to the operator, since moving mechanical parts are exposed. Keep your hands, clothing and hair away from the machine motor compartment until it is shut off.*

During recirculation the dispensing circuits (suction, delivery and recirculation) (Figure 8-4) empty of colorant, which pours into the canisters through the recirculation connector (1) (Figure 8-5).

5. Open the canister section covers and remove the canister lids to make sure that the colorant recirculation caused by initialization is enough to empty the dispensing circuits. When no more colorant enters the canisters through the recirculation connectors, the circuits are empty (Figure 8-5). If the recirculation caused by initialization is not sufficient, send an additional colorant recirculation command from the application program.



6. Shut off the machine and unplug the power supply cable.



Figure 8-4



Figure 8-5

7. You may now proceed with cleaning every filter on the machine (Figure 8-6).

- Find the filter (1) located above the pump.
- Insert a can large enough to collect the residual colorant left in the filter compartment under the filter cap (2).
- Use a suitable wrench to unscrew the filter cap and collect the residual colorant in the can together with the cap and filtering net.
- Insert a clean cloth that leaves no residue of any kind in the filter body; this is essential to prevent colorant from dripping inside the machine.
- If the circuit contains water-based colorant, clean the filtering net thoroughly with running water, warm if possible; use solvent if the circuit contains solvent-based colorant. The filtering net must be replaced if it cannot be cleaned properly.
- Clean the filter cap.
- Insert the filtering net in the filter body and screw the cap back on.

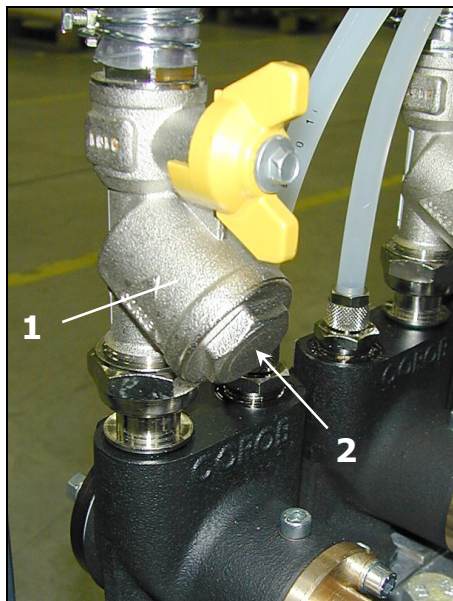

Figure 8-6



Each filter is provided with a tap, whose color changes according to the type of filtering net it contains. When replacing the filtering net, refer to the following table in order to request the right mesh.

Color of the tap	Type of filtering net inside the filter (mm x mm)
BLACK	0.4 x 0.4
YELLOW	0.8 x 0.9
BLUE	1.1 x 1.1
GREEN	1.7 x 1.8
RED	no filtering net

Reset the machine as follows:

8. Open all of the canister taps.
9. Reassemble the protection panels.
10. Connect the machine to the power mains and switch it on (chapter 6.2).

 The machine will initialize when it is turned on; during recirculation the dispensing circuits will fill again with colorant.

11. Check inside the canisters to make sure that the recirculation caused by initialization is enough to fill the dispensing circuits with colorant. When colorant begins entering the canisters through the recirculation connectors, the circuits are full. If the recirculation caused by initialization is not sufficient to send colorant into the canisters, send an additional colorant recirculation command from the application program. Recirculate the colorant until it flows continuously into the canisters.
12. Close the canisters with their corresponding lids, and close the covers of the canister sections.

BLANK PAGE

## 9 SERVICE COMPUTER (for qualified personnel only)

### 9.1 General warnings



The service computer is a personal computer connected to the machine, where the "CorobSERVICE" service and maintenance software is installed; this program allows you to independently activate and deactivate the typical machine processes without necessarily using the management application software.

It is possible to use a laptop computer, or even the machine management computer itself.



This instrument must be used solely by machine service and maintenance personnel.

*Always shut off the machine before connecting the service computer.*



*Never use power cords that are not intact or appropriate.*

***If the machine is shut off while the CorobSERVICE software is running, once the machine is restarted you must exit and re-launch CorobSERVICE.***

For information regarding installation, starting and use of the "CorobSERVICE" service and maintenance software, refer to the corresponding user's manual.

### 9.2 Connecting the service computer

To connect the computer to the machine, it is possible to use a serial cable with a type RJ11 connector (you may use the same cable used for communication between the machine and management computer), or an USB interface cable.

The USB interface cable is no standard equipment, therefore you will have to purchase one suitable for the connection with the dispenser.

Proceed as follows:

1. Position the computer.
2. If the computer is complete with monitor and keyboard, connect as needed.
3. Connect the computer power supply cord to the auxiliary sockets on the rear door (Figure 9-1).

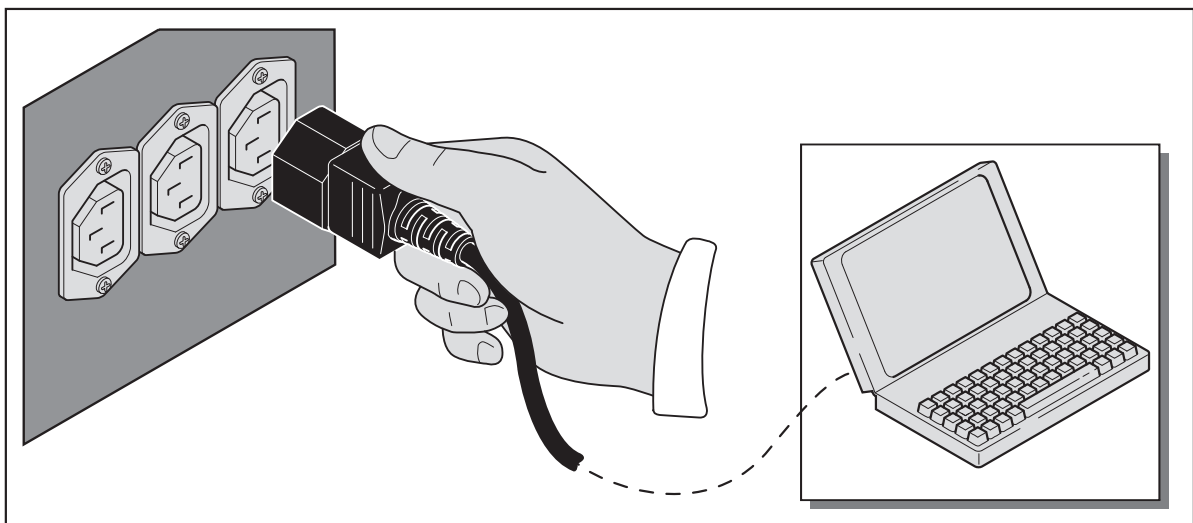



Figure 9-1

## 9-2 9-SERVICE COMPUTER

1. Connect the computer to the machine as follows:

### RS232 serial connection

- Connect the 9-pin female connector of the communication cable to the serial port of the computer (preferably serial port COM1); if the serial port connector of your computer has 25 pins, use a 9/25-pin adapter.
- Insert the communication cable connector (RJ11 male) into the connector (RJ11 female) on the rear door, marked with the symbol  (Figure 9-2).

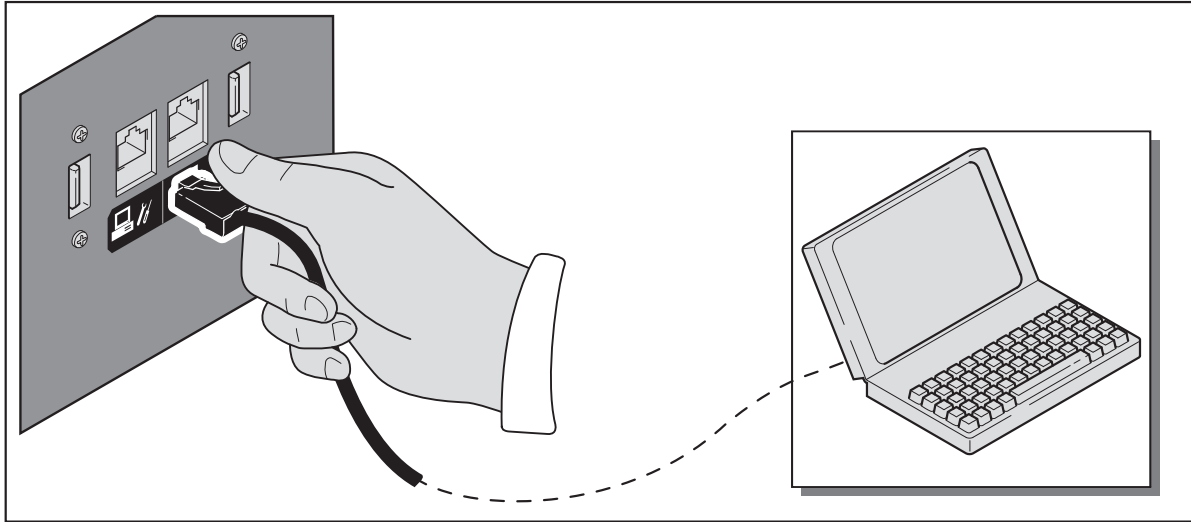



Figure 9-2

### USB connection

- Connect the USB interface cable to the dispenser USB port, marked with the symbol  (Figure 9-3).
- Connect the other end to one of the USB ports of the computer.



Do not use an USB interface cable longer than 2 meters. USB not supported in Microsoft Windows 95 or Microsoft Windows NT 4.0.

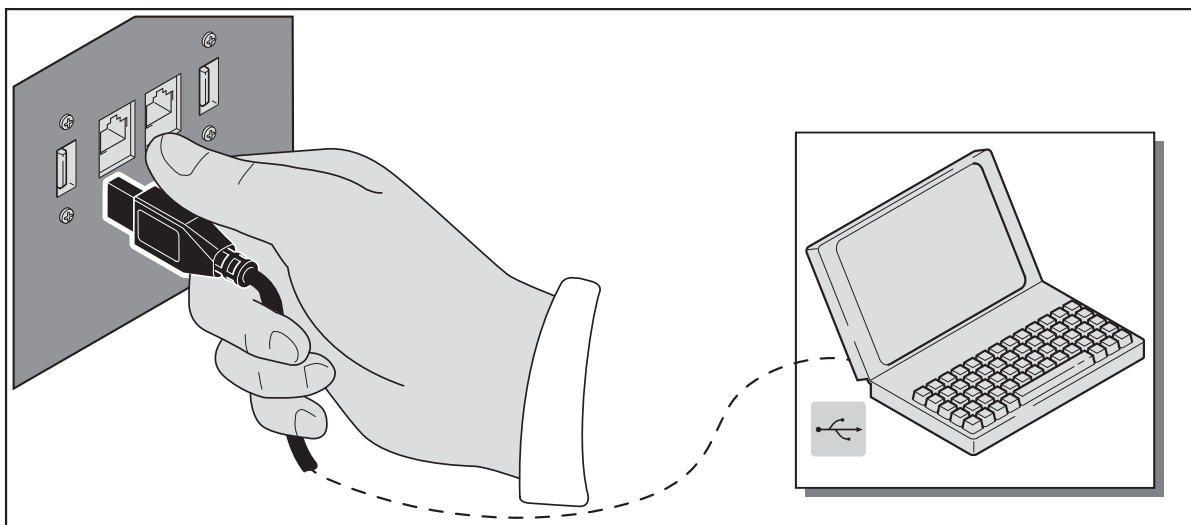

Figure 9-3

4. Turn on the machine (chapter 6.2).

5. Turn on the computer and start the CorobSERVICE program (refer to the corresponding user's manual).



*Even if the auxiliary sockets are not used to power the computer, always make sure the serial cable is connected when the computer is OFF, to prevent damaging the serial line of the machine.*

BLANK PAGE

# 10 GUIDELINES FOR USING VOC-FREE COLORANTS

---

## 10.1 Introduction

---

In compliance with environmental directives from the European Union and various Eco labels, European paint manufacturers are focusing on reducing the solvent levels in their decorative product ranges. The overall target is to develop environmentally friendly paint products without any solvents or volatile organic compounds (VOC). As a part of this development, also the colorants used for colouring these paint products are more commonly VOC-free.

This information chapter is meant as a practical guide for a flawless operation of COROB tinting machines with VOC-free colorants.

 These guidelines are based on information COROB believes is reliable. They are offered in good faith, but without guarantee, as conditions and methods of use of COROB dispensers are beyond COROB's control. It is recommended that the prospective user determine the suitability of the materials and suggestions supplied before adopting them on a commercial scale.

Should you have any further questions, please do not hesitate to contact your local COROB representative directly.

## 10.2 Using VOC-free colorants

---

The choice for a specific type of dispenser and canister size should be based mainly on a realistic estimate of the colorant consumption. For usage with solvent-free colorants special attention should be given to the closing of the canisters and the overall cleaning of the machine. Hereunder you find some recommendations for maintaining the dispenser.

### 10.2.1 Operating conditions

---

If the machine is sold with colorants inside, store the machine at room temperature, and absolutely not in direct sunlight or at temperatures below 0 degrees Celsius.

For a flawless operation, the machine should be used in room temperature, not be placed near heat sources or in direct sunlight. Also humidity sources should be avoided.

### 10.2.2 Filling and refilling

---

Homogenise the colorant according to the instructions provided by the colorant supplier before filling it into the dispenser.

Clean the canister lid before and after filling.

Pour the colorant into the canister.

Maintain the same level of colorant inside the canister, to avoid the colorant drying on the sides of the canister.

### 10.2.3 Daily cleaning

---

Clean each part of the machine that is covered with colorant on a daily basis, especially those parts near the canister lids and the nozzles.

Pay particular attention to the cleaning of the machine before refilling.

### 10.2.4 Humidifying cap / Nozzle washer

---

Clean the humidifying cap or nozzle washer of the machine on a daily basis.

## 10-2 10-GUIDELINES FOR USING VOC-FREE COLORANTS

Refresh the humidifying solution on a daily basis.

### 10.3 Used dispenser by solvent-free colorants

---

Filling in a used dispenser by solvent-free colorants needs special attention paid in following cases:

- The dispenser is currently filled with other VOC-free colorants.
- The dispenser has been used very little and has dried colorant in canisters.

In these cases the dispenser should be properly cleaned before filling it with VOC-free colorants. The following steps are recommended:

1. Empty the canisters completely by dispensing all colorant. If you have dried or almost dried colorants it may be difficult to empty the canister by using the pump. In these cases following additions can be suggested:
  - Add hot water
  - Stir manually
2. Use a brush and hot water to clean the interior of the machine (paddles, sides of canisters, lids, top panels, etc.) thoroughly from solid colorant.
3. Clean the circuit with approximately 2 litres of hot tap water.
4. Clean all exterior surfaces and components of the machine exposed to colorant, including dispense pipes, autocap assembly, shelf, canister covers, canister lids, etc.
5. Fill the canisters with colorant and dispense approximately 200 ml.

### 10.4 What to do in case of a microbial contamination?

---

Due to the absence of solvents and the limitations for usage of biocides, VOC-free colorants provide a more convenient environment for microbes than traditional glycol-based colorants. By following the above-mentioned recommendations, the risk of contamination is limited.

It is however always possible that a solvent-free colorant is contaminated in the dispenser. A contamination is generally characterised by a strong unpleasant odour coming out of the canister and/or the presence of mould.

Should that occur then take the following action:

1. Remove the contaminated colorant from the canister.
2. Contact the colorant supplier for further actions regarding the colorant.
3. Empty the canister with contaminated colorant completely by dispensing all colorant.
4. Use a brush and hot water to clean the interior of the machine (paddles, sides of canisters, lids, top panels, etc.) thoroughly from solid colorant.
5. Clean the circuit with hot tap water until the water is no longer coloured.
6. Clean all exterior surfaces and components of the machine exposed to colorant, including dispense pipes, autocap assembly, shelf, canister covers, canister lids, etc.
7. Pour 2-3 litres of biocide solution into the canister (as regards the more suitable biocide solution composition contact your colorant supplier).
8. Re-circulate the solution and let it sit in the circuit and canister for about 1 hour.
9. Dispense out all biocide solution.
10. Fill the canister with fresh colorant and dispense approximately 200 ml.



## 11 BUNG HOLE LOCATOR LASER WARNINGS

### 11.1 Laser equipment safety

The CEI EN 60825-1 standard sets the maximum exposure limits for laser radiation. The main organs at risk are the eyes and skin. An excessive exposure to laser radiation can cause burns and lesions of the retinal tissue. The situations with the greatest risk are the observation of the direct beam and the specular reflected beam. The dangerousness of the laser depends on the wave length, exposure time and type of functioning.

The dispenser, if equipped with the Bung hole locator Laser (B.H.L.), is fitted with a *Class 2* laser in compliance with the applicable standards. Lasers in this class emit radiations in the visible interval with optical power below 1mW. Accidental exposure is not dangerous for this type of laser source as the palpebral reflex does not allow for an exposure time greater than 0.25 seconds.

For the user's safety the following precautions must be adopted.



### WARNINGS





- All operators must be instructed on the operations, functioning, risks and safety regulations of the type of laser used.
- Do not point the beam in eyes and avoid staring at the laser when it is functioning.
- Switch on the laser only to center the can.
- Do not leave the machine with the laser switched on unattended.
- Reference standards

The machine complies to CEI EN 60825-1, EN 61326-1 and EN 61010-1 standards as far as laser equipment safety is concerned.

### 11.2 Position of labels

The following warning labels that list the class, type and warnings for the type of laser used, are applied on the machine in a readable and clearly visible position:

N.	Description	
1	Laser Danger Label – Triangular warning label with black edging on a yellow background with the laser symbol.	
2	Rectangular information label with black edging and writing on a yellow background. It indicates the maximum laser radiation power emitted, the wave length emitted and the name and publishing date of the standard used to classify the equipment.	

BLANK PAGE

## Dichiarazione CE di Conformità *EC Declaration of Conformity*

Versione linguistica originale in Italiano

*Translation of the original Italian version*

DESCRIZIONE - *DESCRIPTION*

**DISPENSATORE AUTOMATICO  
AUTOMATIC DISPENSER**

MODELLO - *MODEL*

MATRICOLA - *SERIAL No.*

**[MACHINE NAME]**

Fabbricante e persona autorizzata a costituire il fascicolo tecnico:  
*Manufacturer and person authorised to compile the technical file:*

**COROB S.p.A.**

**Via Agricoltura, 103 - 41038 San Felice s/P (MO) - Italy**

Il fabbricante dichiara sotto la propria esclusiva responsabilità che la macchina alla quale questa dichiarazione si riferisce è conforme ai requisiti essenziali previsti dalle seguenti direttive:

*The manufacturer certifies, under its own responsibility, that the machine to which this statement refers to, complies with the essential requirements foreseen by the regulations:*

- Direttiva Macchine 2006/42/CE
- Direttiva Compatibilità Elettromagnetica 2014/30/EU
- Direttiva 2011/65/EU come modificata da 2015/863/EU
- Direttiva WEEE 2012/19/EU

- *Machinery Directive 2006/42/EC*
- *Electromagnetic Compatibility Directive 2014/30/EU*
- *Directive 2011/65/EU as amended by 2015/863/EU*
- *WEEE Directive 2012/19/EU*

Si garantisce poi che la progettazione della macchina e la relativa produzione è effettuata, e documentata, seguendo precise procedure aziendali conformi con la norma EN ISO 9001:2015 inerente i sistemi di gestione qualità.

*It is furthermore guaranteed that the design of the machine and the relevant manufacturing are carried out, and supported by documents, following accurate factory procedures in accordance with the standard EN ISO 9001:2015 about quality management systems.*

Andrea Alvisi  
(Special Proxy Holder)  
COROB S.p.A.  
San Felice sul Panaro, 10/05/2021

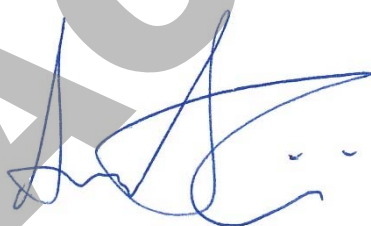

**BG** - Производителят, който е лицето изпълнено от изготвяне на техническата документация, декларира на собствена изключителна отговорност, че машината, за която се отнася тази декларация, е в съответствие със съществените изисквания, предвидени от следните Директиви: Директива 2006/42/EC - Машини - Директива 2014/30/EU относно Електромагнитна съвместимост - Директива 2011/65/EU изменена с 2015/863/EU - Директива WEEE 2012/19/EU. Освен това се гарантира, че проектирането на машината и съответното производство са извършени и документирани при спазване на конкретни фирмени процедури в съответствие със стандарт EN ISO 9001:2015, отнасящ се до системите за управление на качеството.

**CS** - Výrobce a osoba pověřená sestavením technické dokumentace stvrzují na svou vlastní zodpovědnost, že zařízení, ke kterému se toto toto prohlášení vztahuje, je v souladu se základními požadavky stanovenými následujícími směnicemi: Směrnice o strojních zařízeních 2006/42/EC - Směrnice o elektromagnetické kompatibilitě 2014/30/EU - Směrnice 2011/65/EU ve znění 2015/863/EU - Směrnice WEEE 2012/19/EU. Dále se zaručuje, že stroj byl navržen a vyroben, a výroba je zdokumentována, v souladu s přesnými firemními postupy, které odpovídají normě EN ISO 9001:2015 o systémech řízení jakosti.

**DA** - Fabrikanten og personen bemyndiget til at udarbejde den tekniske dokumentation erklærer på eget ansvar at maskinen, som denne erklæring henviser til, er i overensstemmelse med de væsentlige krav i de følgende direktiver: Maskindirektivet 2006/42/EC - Direktivet om elektromagnetisk kompatibilitet 2014/30/EU - Direktivet 2011/65/EU som ændret ved 2015/863/EU - Direktivet WEEE 2012/19/EU. Det garanteres desuden, at designet af maskinen og den relevante produktionsproces er udført og dokumenteret ifølge præcise fabriksprocedurer i overensstemmelse med standarden EN ISO 9001:2015 vedrørende kvalitetsstyringssystemer.

**DE** - Der Hersteller und autorisierte Verfasser der technischen Dokumentation erklärt unter eigener exklusiver Verantwortung, dass die Maschine, auf die sich diese Erklärung bezieht, den Grundanforderungen entspricht, die von den folgenden Richtlinien vorgesehen werden: Maschinenrichtlinie 2006/42/EC - Richtlinie zur elektromagnetischen Verträglichkeit 2014/30/EU - Richtlinie 2011/65/EU geändert durch 2015/863/EU - Richtlinie WEEE 2012/19/EU. Darüber hinaus wird garantiert, dass die Planung der Maschine und ihre Herstellung unter Befolgung von genauen Unternehmensprozessen, die der Norm EN ISO 9001:2015 hinsichtlich der Qualitätsmanagement-Systeme entsprechen, durchgeführt und dokumentiert wird.

**EL** - Ο κατασκευαστής, και ο εξουσιοδοτημένος συντάκτης του τεχνικού φακέλου, πιστοποιεί, ότι, με δική του υπαιτιότητα, το μηχάνημα στο οποίο αναφέρεται το παρόν, συμμορφώνεται με τις ουσιαστικές απαιτήσεις που προβλέπονται από τους κανονισμούς: Οδηγία Μηχανήματος 2006/42/EC - Οδηγία Ηλεκτρομαγνητικής Συμβατότητας 2014/30/EU - Οδηγία 2011/65/EU όπως τροποποιήθηκε από το 2015/863/EU - Οδηγία WEEE 2012/19/EU. Εγγυάται περαιτέρω ότι ο σχεδιασμός του μηχανήματος και η σχετική κατασκευή του εκτελείται και υποστηρίζεται από έγγραφα, ακολουθώντας τις ακριβείς εργοστασιακές διαδικασίες σύμφωνα με το πρότυπο EN ISO 9001:2015 σχετικά με τα συστήματα διαχείρισης ποιότητας.

**ES** - El fabricante y la persona autorizada para componer el fascículo técnico declara, bajo su propia y exclusiva responsabilidad, que la máquina a la que hace referencia esta declaración guarda conformidad con los requisitos esenciales previstos por las directivas siguientes: Directiva de máquinas 2006/42/EC - Directiva de compatibilidad electromagnética 2014/30/EU - Directiva 2011/65/EU modificada por 2015/863/EU - Directiva WEEE 2012/19/EU. Se garantiza además que el diseño de la máquina y su producción se han efectuado y documentado de acuerdo con procedimientos de fábrica precisos conformes a la normativa EN ISO 9001:2015 relativa a los sistemas de gestión de calidad.

**ET** - Tootja ja tehnilise toimiku koostajaks volitatud isik kinnitab oma täielikul vastutusel, et seade, mille käesolev avaldus viitab, vastab järgnevate regulatsioonide põhinõudmistele: Masinadirektiiv 2006/42/EC - Elektromagnetilise ühilduvuse direktiiv 2014/30/EU - Direktiiv 2011/65/EU muudetud 2015/863/EU-ga - Direktiiv WEEE 2012/19/EU. Peale selle on garanteeritud, et seadme projekteerimisel ja tootmisel on järgitud täpseid tehaseprotseduure, mis vastavad standardile EN ISO 9001:2015 kvaliteedijuhimissüsteemide kohta, ning et seadme toetab ka vastav dokumentatsioon.

**FI** - Valmistaja ja henkilö, joka on valtuutettu laatimaan tekninen asiakirja-aineisto, vakuuttavat omalla vastuullaan, että kone, johon tämä lausunto viittaa, vastaa seuraavien direktiivien olennaisia vaatimuksia: Konedirektiivi 2006/42/EC - Sähkömagneettista yhteensopivuutta koskeva direktiivi (EMC) 2014/30/EU ja Direktiivi 2011/65/EU sellaisena kuin se on muutettuna direktiivillä 2015/863/EU - Direktiivi WEEE 2012/19/EU. Lisäksi taataan, että koneen suunnittelussa ja valmistelussa ja näiden dokumentoinnissa noudatetaan tarkkoja menettelytapoja, jotka täyttävät laadunhallintaa koskevan EN ISO 9001:2015 -standardin vaatimukset.

**FR** - Le fabricant, et toute personne autorisée à établir le dossier technique, déclare sous sa propre responsabilité que la machine à laquelle se rapporte cette déclaration est conforme aux exigences essentielles prévues par les directives suivantes : Directive Machines 2006/42/EC - Directive Compatibilité Électromagnétique 2014/30/EU - Directive 2011/65/EU telle que modifiée par 2015/863/EU - Directive WEEE 2012/19/EU. Le fabricant garantit également que la conception de la machine, ainsi que sa production, ont été effectuées et documentées, en suivant des procédures d'entreprise précises conformes à la norme EN ISO 9001:2015 relative aux systèmes de gestion qualité.

**GA** - Dearbhaíonn an déantóir, agus an duine atá údaraithe chun an comhad teicniúil a chur le chéile, ar a fheargracht féin go bhfuil an gléas a mbaineann an ráiteas seo leis i gcomhréir leis na riachtanais atá leagtha amach sna treoracha seo a leanas: Treoir um Innealra 2006/42/EC - Treoir um Chomhoiriúnacht Leictreamaighnéadach 2014/30/EU - Treoir 2011/65/EU arna leasú le 2015/863/EU - Treoir WEEE 2012/19/EU. Deimhnítear freisin go bhfuil dearadh an ghléas agus a dhéantús déanta, agus doiciméadaithe, de réir gnásanna beachta an chomhlachta atá i gcomhréir leis an rial EN ISO 9001:2015 a bhaineann le córais bainistíochta cáilíochta.

**HR** - Proizvođač, i osoba ovlaštena za sastavljanje tehničke dokumentacije, izjavljuje pod svojom punom odgovornošću da je stroj na koji se odnosi ova izjava sukladan bitnim zahtjevima slijedećih direktiva: Direktive o strojevima 2006/42/EC - Direktive o elektromagnetskoj kompatibilnosti 2014/30/EU - Direktive 2011/65/EU izmijenjena i dopunjena 2015/863/EU - Direktive WEEE 2012/19/EU. Također, jamči se da su projektiranje stroja i njegova proizvodnja izvedeni i dokumentirani slijedeći precizne tvorničke procedure sukladne normi EN ISO 9001:2015 o sustavima upravljanja kvalitetom.

**HU** - A gyártó, valamint a műszaki fizet ősszeállítására felhatalmazott személy saját felelősségük tudatában kijelentik, hogy a jelen nyilatkozat tárgyát képező gép megfelel az alábbi irányelvek alapvető rendelkezéseinek: 2006/42/EC Gépek irányelv - 2014/30/EU Elektromágneses kompatibilitás irányelv - 2011/65/EU irányelv, módosítással módosított 2015/863/EU irányelv - WEEE 2012/19/EU irányelv. A gyártó garantálja továbbá, hogy a gép tervezése, kivitelezése, valamint a folyamat dokumentálása az üzemi előírások precíz betartásával történik, a minőségkezelési rendszerekkel falkozkozó EN ISO 9001:2015 szabvánnyal összhangban.

**IS** - Framleiðandinn, og einstaklingurinn sem hefur heimild til að taka saman tækniskjölin, vottar, að eigin ábyrgð, að velin sem vísað er til í þessari yfirlýsingu, sé í samræmi við þær grunnkröfur sem gert er ráð fyrir í eftirfarandi reglugerðum: Vélátalskipun 2006/42/EC - Tilskipun um rafsegulsviðsamhæfi 2014/30/EU - Tilskipun 2011/65/EU eins og henni var breytt með 2015/863/EU - Tilskipun WEEE 2012/19/EU. Ennfremur er ábyrgt að hönnun vélarinnar og tengd framleiðsla fer fram, og er það skjalsett, í samræmi við nákvæmt framleiðsluferli og í samræmi við EN ISO 9001:2015 staðalinn um gæðastjórnunarkerfi.

**LT** - Gamintojas ir asmuo įgaliotas sudaryti techninę dokumentaciją, savo atsakomybę pareiškia, kad staklės, kurioms skirta ši deklaracija, atitinka esminius šių direktyvų reikalavimus: Mašinų direktyva 2006/42/EC - Elektromagnetinio suderinamumo direktyva 2014/30/EU - Direktyva 2011/65/EU su pakeitimais, padarytais 2015/863/EU - Direktyva WEEE 2012/19/EU. Taip pat užtikrinama ir dokumentais patvirtinama, kad staklės buvo sukurtos ir pagamintos tiksliai laikantis gamybos reikalavimų pateiktų EN ISO 9001:2015 standarte, dėl kokybės valdymo sistemu.

**LV** - Ražotājs un persona, kas ir pilnvarota sastādīt tehnisko dokumentāciju, apliecina uz savu atbildību, ka mašina, uz kuru šī deklarācija attiecas, atbilst šādu direktīvu: pamatprasībām Mašīnu Direktīva 2006/42/EC - Elektromagnētiskās sadarbības Direktīva 2014/30/EU - Direktīva 2011/65/EU grozīta ar 2015/863/EU pantu - Direktīva WEEE 2012/19/EU. Tiek arī nodrošināts, ka mašīnas dizains, pēc precīziem biznesa procesiem atbilst standartā EN ISO 9001:2015 prasībām attiecībā uz vadības sistēmu kvalitāti.

**MT** - Il-manifattur, u l-persuna awtorizzata biex tikkompila l-fajl tekniku jiddikjarwar taht ir-responsabilita taghhom stess li l-magna li ghalha qed issir din id-dikjarazzjoni hija konformi ghar-reqwiziti essenzjali previsti mid direttivi li ghejin: Direttiva dwar il-Magni 2006/42/EC - Direttiva dwar il-Kompatibilita Elettromanjetika 2014/30/EU - Direttiva 2011/65/EU kif emendata b'2015/863/EU - Direttiva WEEE 2012/19/EU. Dan jizgura wkoll li d-disinn tal magna u l-produzzjoni taghha jsiru, u jigu d-dokumentati wara processi tan-negozju precizii li huma konformi ma' EN ISO 9001:2015 dwar is-sistemi ta' gestjoni tal-kwalita.

**NL** - De fabrikant en gemachtigde voor het samenstellen van het technisch dossier verklaart dat het betreffende toestel voldoet aan de toepasselijke fundamentele voorschriften van de volgende richtlijnen: Machineryrichtlijn 2006/42/EC - EMC-richtlijn 2014/30/EU - Richtlijn 2011/65/EU zoals gewijzigd bij 2015/863/EU - Richtlijn WEEE 2012/19/EU. Verder wordt gegarandeerd dat het ontwerp en de productie van het toestel werd gedocumenteerd en geïmplementeerd volgens de vereisten van de norm EN ISO 9001:2015 voor kwaliteitsmanagementsystemen.

**NO** - Produzenten og den personen som er autorisert til å utstede den tekniske dokumentasjonen, erklærer under eget ansvar, at den maskinen denne erklæringen viser til, er i samsvar med de grunnleggende kravene som fremsettes i følgende direktiv: Maskindirektivet 2006/42/EC - Direktivet om elektromagnetisk kompatibilitet 2014/30/EU - Direktiv 2011/65/EU som endret ved 2015/863/EU - Direktiv WEEE 2012/19/EU. Det garanteres videre at utformingen av maskinen og den påfølgende framstillingen er blitt utført og dokumentert etter spesifikke prosedyrer for selskapet, i samsvar med regelverket NS-EN ISO 9001:2015 om ledelsessystem for kvalitet.

**PL** - Producent oraz osoba upoważniona do sporządzenia dokumentacji technicznej zaświadcza na własną, wyłączną odpowiedzialność, że maszyna, której dotyczy niniejsza deklaracja, jest zgodna z zasadniczymi wymaganiami przewidzianymi w następujących dyrektywach: Dyrektywa Maszynowa 2006/42/EC - Dyrektywa Kompatybilności Elektromagnetycznej 2014/30/EU - Dyrektywa 2011/65/EU zmieniona przez 2015/863/EU - Dyrektywa WEEE 2012/19/EU. Ponadto gwarantuje się, że fazy projektowania oraz produkcji maszyny zostały przeprowadzone oraz są udokumentowane według dokładnych procedur zakładowych, zgodnych z normą EN ISO 9001:2015, dotyczącą systemów zarządzania jakością.

**PT** - O Fabricante e a pessoa autorizada a preencher o documento técnico declaram, à sua inteira e exclusiva responsabilidade, que a máquina a que se refere esta declaração está em conformidade com os requisitos essenciais estabelecidos pelas seguintes diretivas: Diretiva Máquinas 2006/42/EC - Diretiva Compatibilidade Eletromagnética 2014/30/EU - Diretiva 2011/65/EU alterada pela 2015/863/EU - Diretiva WEEE 2012/19/EU. É também garantido que a conceção e produção da máquina são efetuadas e documentadas de acordo com procedimentos empresariais específicos em conformidade com a norma EN ISO 9001:2015 relativa aos sistemas de gestão da qualidade.

**RO** - Fabricantul și persoana autorizată pentru realizarea dosarului tehnic declară pe propria răspundere că mașina la care se referă prezenta declarație se conformează cerințelor esențiale prevăzute de următoarele directive: Directiva 2006/42/EC Mașini - Directiva 2014/30/EU Compatibilitatea electromagnetică - Directiva 2011/65/EU astfel cum a fost modificat de 2015/863/EU - Directiva WEEE 2012/19/EU. Se garantează, de asemenea, că proiectarea mașinii și producția acesteia, documentate corespunzător, se efectuează cu respectarea unor proceduri de întreprindere specifice, conforme cu standardul EN ISO 9001:2015 aferent sistemelor de management al calității.

**SK** - Výrobca a osoba poverená vypracovaním technickej dokumentácie na vlastnú zodpovednosť prehlasujú, že stroj, na ktorý sa toto prehlásenie vzťahuje, je v súlade so základnými požiadavkami, ktoré vyžadujú nasledujúce smernice: Smernica o strojných zariadeniach 2006/42/EC - Smernica o elektromagnetickej kompatibilitě 2014/30/EU - Smernica 2011/65/EU zmenená a doplnená 2015/863/EU - Smernica WEEE 2012/19/EU. Ďalej sa zaručuje, že stroj bol navrhnutý a vyrobený, a výroba je zdokumentovaná, v súlade s presnými firemnými postupmi, ktoré zodpovedajú norme EN ISO 9001:2015 o systémoch riadenia kvality.

**SL** - Proizvajalec in oseba, pooblašena za sestavo tehničnega dokumenta, s polno odgovornostjo izdaja potrdilo, da je stroj, predmet te izjave, izdelan v skladu z osnovnimi zahtevami, kot jih določajo predpisi: Direktiva o strojih 2006/42/EC - Direktiva o elektromagnetni združljivosti 2014/30/EU - Direktiva 2011/65/EU kakor je bila spremenjena z 2015/863/EU - Direktiva WEEE 2012/19/EU. Jamčimo tudi za obliko sistema in predmetno izdelavo, pri katerih smo opravili postopke in pripravili ustrezno dokumentacijo v skladu z ustrezno tovarniško prakso in predpisom EN ISO 9001:2015, ki velja za sisteme zagotavljanja kakovosti.

**SV** - Tillverkaren och den person som har befogenhet att sammanställa den tekniska dokumentationen intygar, på eget ansvar, att maskinen denna försäkran hänvisar till överensstämmer med de väsentliga krav som ställs av följande direktiv: Maskindirektivet 2006/42/EC - Direktivet om elektromagnetisk kompatibilitet 2014/30/EU - Direktivet 2011/65/EU ändrat genom 2015/863/EU - Direktivet WEEE 2012/19/EU. Det garanteras vidare att utformningen av maskinen och därtill hörande tillverkning genomförs dokumenterat, i enlighet med exakta fabriksförfaranden som följer standard EN ISO 9001:2015 om system för kvalitetsstyrning.

**TR** - Üretici ve teknik dosyası oluşturmakla görevli kişi bu beyanını ilgili oduğ u makinenin, aşağıdaki direktifler tarafından öngörülen temel gerekliliklere uygun oduğ unu kendi sorumluluğ u altında beyan eder: 2006/42/EC Makine Direktifi - 2014/30/EU Elektromanyetik Uyumluluk Direktifi - 2015/863/EU tarafından değıstirilen 2011/65/EU sayılı Direktif - WEEE 2012/19/EU Direktifi. Bundan başka, makinenin tasarımı ve ilgili üretimi, kalite yönetimi sistemlerine ilişkin EN ISO 9001:2015 standardına uygun kesin işleme prosedürlerinin izlenmesi yoluyla gerçekleştirilmesi ve belgelendirilmesi sağlanır.